

General Specifications

ROTAMASS Total Insight Coriolis Mass Flow and Density Meter Prime



GS 01U10B04-00EN-R



Rotamass Prime - Versatility with superior turndown and low pressure loss

Features and benefits

- Precise flow rate measurement over wide flow range of liquids or gases. Also handling multi-phase fluids and liquid with gas content
- Wide measuring range of mass and volume flow, density, temperature and concentration measurements
- Contribution to energy-saving operation by low pressure loss design with short tube paths and large tube diameter
- Cost effective short face-to-face length or customized installation length options
- Benefit from Viscosity function and capability to handle high viscous process fluids

Process Guard

Operation and Observation

- Meter Performance under wide process conditions
- Meter Verification in line by Tube Health Check function

Table of contents

1	Introduction	4
1.1	About this General Specification	4
1.2	Applicable documents	4
1.3	Measuring system	5
1.4	Transmitter	6
2	Application and measuring ranges	7
2.1	Measured quantities	7
2.2	Mass flow	8
2.3	Pressure loss	9
2.4	Density	9
2.5	Process fluid temperature range	9
3	Accuracy	10
3.1	Overview	10
3.2	Zero point stability of the mass flow	11
3.3	Mass flow accuracy	12
3.4	Accuracy of density	14
3.4.1	For liquids	14
3.4.2	For gases	14
3.5	Accuracy of mass flow and density according to the model code	15
3.5.1	For liquids	15
3.5.2	For gases	16
3.6	Volume flow accuracy	16
3.6.1	For liquids	16
3.6.2	For gases	16
3.7	Accuracy of temperature	17
3.8	Repeatability	17
3.9	Calibration conditions	18
3.9.1	Mass flow calibration and density adjustment	18
3.9.2	Density calibration	18
3.9.3	Calibration for gases	18
3.10	Process conditions	19
3.10.1	Process pressure effect	19
3.10.2	Process fluid temperature effect	19
3.11	Analog output specification	21
4	Operating conditions	22
4.1	Location and position of installation	22
4.1.1	Sensor installation position	23
4.2	Process conditions	24
4.2.1	Pressure	24
4.2.2	Secondary containment	27
4.3	Ambient conditions	28
4.3.1	Allowed ambient temperature for sensor	29
4.3.2	Temperature specification in hazardous areas	31

5	Mechanical specification	44
5.1	Design	44
5.2	Material	45
5.2.1	Sensor	45
5.2.2	Transmitter	45
5.2.3	Nameplates	46
5.3	Process connections, dimensions and weights of sensor	47
5.4	Transmitter dimensions and weights	59
6	Electrical specification	61
6.1	Power supply	61
6.2	Electrical interfaces	61
6.2.1	Analog inputs and outputs	62
6.2.2	Digital inputs and outputs	65
6.2.3	HART	69
6.2.4	Modbus	71
6.2.5	PROFIBUS PA	72
6.2.6	FOUNDATION Fieldbus	74
6.3	Display and microSD card	76
6.4	Cable specifications	77
7	Approvals and declarations of conformity	78
7.1	Legal equipment standards and norms	79
7.2	Application and industry related standards	80
7.3	Communication interface standards	81
7.4	Other standards and guidelines	81
7.5	Hazardous area	82
8	Ordering information	86
8.1	Model code description	86
8.2	Available model codes per basic model	94
8.3	Model code combinations	98
8.4	Ordering Instructions	99
8.4.1	Mandatory ordering instructions	99
8.4.2	Optional ordering instructions	99

1 Introduction

This specification provides overview about Rotamass Total Insight portfolio. Complete specification is available per product line.

1.1 About this General Specification

All available properties of the Rotamass Coriolis flow meter are specified by means of a model code.

One model code position may include several characters depicted by means of dashed lines.

The positions of the model code relevant for the respective properties are depicted and highlighted in blue. Any values that might occupy these model code positions are subsequently explained.

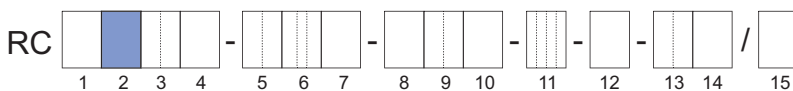

Fig. 1: Highlighted model code positions

A complete description of the model code is included in the chapter 8 *Ordering information* [86].

1.2 Applicable documents

The following documents supplement this specification:

Document title	Document number
General Specifications:	
▪ General Specifications Rotamass Specification Overview	GS 01U10B00-00__-R ¹⁾
▪ General Specifications Rotamass Features on Demand (FOD)	GS 01U10B20-00__-R ¹⁾
▪ General Specifications Rotamass Spare Transmitter	GS 01U10B21-00__-R ¹⁾
Instruction Manuals:	
▪ General Instruction Manual	IM 01U10B00-00__-R ¹⁾
▪ Quick Reference Instruction Manual	IM 01U10A00-00__-R ¹⁾
▪ Quick Reference Instruction Manual for Spare	IM 01U10A01-00__-R ¹⁾
Explosion proof type Manuals:	
▪ Explosion Proof Type Manual ATEX	IM 01U10X01-00__-R ¹⁾
▪ Explosion Proof Type Manual IECEx	IM 01U10X02-00__-R ¹⁾
▪ Explosion Proof Type Manual FM	IM 01U10X03-00__-R ¹⁾
▪ Explosion Proof Type Manual INMETRO	IM 01U10X04-00__-R ¹⁾
▪ Explosion Proof Type Manual PESO	IM 01U10X05-00__-R ¹⁾
▪ Explosion Proof Type Manual NEPSI	IM 01U10X06-00__-R ¹⁾
▪ Explosion Proof Type Manual Korea-Ex	IM 01U10X07-00__-R ¹⁾
▪ Explosion Proof Type Manual EAC-Ex	IM 01U10X08-00__-R ¹⁾
▪ Explosion Proof Type Manual Japan Ex	IM 01U10X09-00__-R ¹⁾
▪ Explosion Proof Type Manual UKEx	IM 01U10X11-00__-R ¹⁾
Software Instruction Manuals:	
▪ Software Instruction Manual HART	IM 01U10S01-00__-R ¹⁾
▪ Software Instruction Manual FOUNDATION Fieldbus	IM 01U10S02-00__-R ¹⁾
▪ Software Instruction Manual Modbus	IM 01U10S03-00__-R ¹⁾
▪ Software Instruction Manual PROFIBUS PA	IM 01U10S04-00__-R ¹⁾

¹⁾ The "_" symbols are placeholder for the corresponding language version of the document (EN, DE, etc.).



The complete product documentation is stored on the microSD card delivered with the device and is available at:

- Yokogawa Customer Portal (<http://myportal.yokogawa.com/s/documents>)
- Yokogawa Device Lifecycle Management app

Please enter the serial number of the device or scan the QR code on the device.

1.3 Measuring system

The Rotamass Coriolis flow meter consists of:

- Sensor
- Transmitter

When the integral type is used, sensor and transmitter are firmly connected.

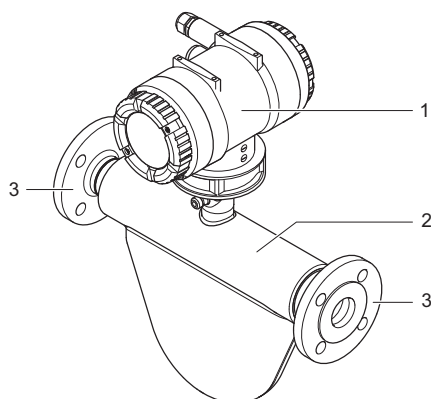

Fig. 2: Configuration of the Rotamass integral type

- | | |
|---|---------------------|
| 1 | Transmitter |
| 2 | Sensor |
| 3 | Process connections |

When the remote type is used, sensor and transmitter are linked via connecting cable. As a result, sensor and transmitter can be installed in different locations.

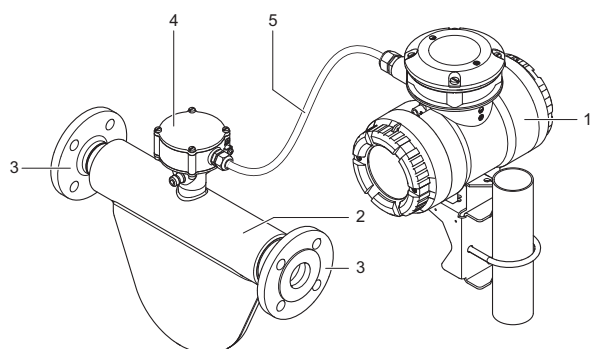
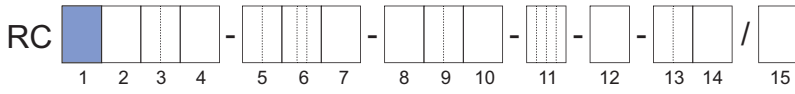

Fig. 3: Configuration of the Rotamass remote type

- | | | | |
|---|---------------------|---|---------------------|
| 1 | Transmitter | 4 | Sensor terminal box |
| 2 | Sensor | 5 | Connecting cable |
| 3 | Process connections | | |

1.4 Transmitter

The sensor can be combined with different transmitters. The transmitter type is visible in the indicator.



Essential Transmitter

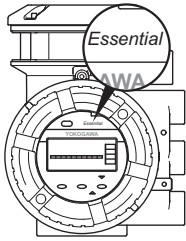

Ultimate Transmitter

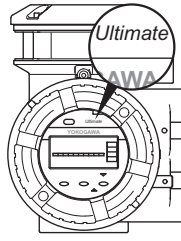

Model code position 1	Transmitter type	Description	Communication Interfaces
E	Essential	Basic functions	HART, Modbus
U	Ultimate	Advanced functions	HART, Modbus, PROFIBUS PA, FOUNDATION Fieldbus

Transmitter functions are described in detail in the Specification overview GS01U10B00-00_ _-R.

For details about available functions per transmitter type refer to chapter *Ordering information* [▶ 86].

2 Application and measuring ranges



In this chapter, all values related to pressure are gauge pressure values.



For process specific results, please refer to the FlowConfigurator online sizing and configuration tool: <http://www.FlowConfigurator.com>

2.1 Measured quantities

The Rotamass Coriolis flow meter can be used to measure the following fluids:

- Liquids
- Gases
- Mixtures, such as emulsions, suspensions, slurries

Possible limitations applying to measurement of mixtures must be checked with the responsible Yokogawa sales organization.

The following variables can be measured using Rotamass:

- Mass flow
- Density
- Temperature

Based on these measured quantities, the transmitter also calculates:

- Volume flow
- Partial component concentration of a two-component mixture
- Partial component flow rate of a mixture consisting of two components (net flow)

The net flow is calculated based on the known partial component concentration and the overallflow.

The mass flow, volume flow, net flow measurements can be bi-directional.

Measured quantities for NTEP custody transfer approval

Measurement variables for NTEP approval options /Q20 are:

- Mass flow unidirectional
- Volume flow unidirectional

2.2 Mass flow

For Rotamass Prime the following meter sizes to be determined using the *Model code description* [86] are available.

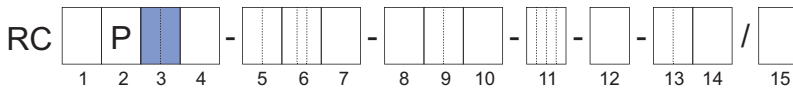

Meter size	Typical connection size	Q _{nom} in t/h (lb/min)	Q _{max} in t/h (lb/min)	Model code position 3
Prime 25	DN25, 1"	1.60 (59)	2.30 (85)	25
Prime 40	DN40, 1½"	4.70 (170)	7.00 (260)	40
Prime 50	DN50, 2"	20.00 (730)	29.00 (1100)	50
Prime 80	DN80, 3"	51.00 (1900)	76.00 (2800)	80
Prime 1H	DN100, 4"	170 (6200)	255.00 (9400)	1H

Mass flow measuring range for NTEP custody transfer approval

Tab. 1: Mass flow measuring ranges (/Q20)

Meter size	Q _{min} in t/h (lb/min)	Q _{max} in t/h (lb/min)
Prime 25	0.23(8.38)	2.30 (83.78)
Prime 40	0.60 (22.05)	6.00(220.46)
Prime 50	2.88 (105.82)	28.80(1058.22)
Prime 80	6.00(220.46)	60.00(2204.62)
Prime 1H	12.00 (440.92)	120.00(4409.25)

Q_{nom} - Nominal mass flow

Q_{max} - Maximum mass flow

Q_{min} - Minimum mass flow

The nominal mass flow Q_{nom} is defined as the mass flow of water (temperature: 20 °C) at 1 bar (14.5 psi) pressure loss across the flow meter.

Mass flow of gases

When using Rotamass for measuring the flow of gases, the mass flow is usually limited by the pressure loss generated and the maximum flow velocity.

Type of gas	Meter size	Maximum flow velocity
Oxygen	All	60 m/s
Methane Natural gas	All	70 m/s
Other gases	All	33 % of sound velocity

2.3 Pressure loss

The pressure loss along the flow meter is heavily dependent on the application. The pressure loss of 1 bar at nominal mass flow Q_{nom} also applies to water and is considered the reference value.

2.4 Density

Meter size	Measuring range of density in kg/l (lb/ft ³)
Prime 25	0 – 5 (0 – 312)
Prime 40	
Prime 50	
Prime 80	
Prime 1H	

Density measuring range for NTEP custody transfer approval

Tab. 2: Density measuring ranges (/Q20)

Option	Measuring range of density in kg/l (lb/ft ³)
/Q20	0,9 – 1,1 (56 – 69)

Density of gases

Rather than being measured directly, density of gas is usually calculated using its reference density, process fluid temperature and process pressure.

2.5 Process fluid temperature range



Allowed process fluid and ambient temperature ranges in hazardous areas depend on classifications defined by applications, refer to *Temperature specification in hazardous areas* [▶ 31].

For Rotamass Prime the following process fluid temperature ranges are available:

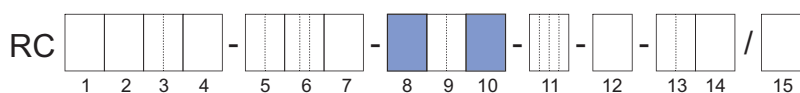

Temperature range	Model code position 8	Process fluid temperature in °C (°F)	Design type	Model code position 10
Standard	0	-50 – 150 (-58 – 302)	Integral type	0, 2
		-70 – 200 (-94 – 392)	Remote type	A, E, J

3 Accuracy

In this chapter, maximum deviations are indicated as absolute values.



All accuracy data are given in ± values.

3.1 Overview

Achievable accuracies for liquids

The value D_{flat} specified for accuracy of mass flow applies for flow rates exceeding the mass flow limit Q_{flat} . If the flow rate is less than Q_{flat} , other effects have to be considered.

If the flow rate is higher than Q_{nom} , other effects might influence the accuracy (e.g. cavitation).

The following values are achieved at calibration conditions when the device is delivered, see *Calibration conditions* [▶ 18].

Measured quantity		Accuracy for transmitters	
		Essential	Ultimate
Mass flow ¹⁾	Accuracy ²⁾ D_{flat}	0.2 % of measured value	0.1 % of measured value
	Repeatability ³⁾	0.1 % of measured value	0.05 % of measured value
Volume flow (water) ¹⁾	Accuracy ²⁾ D_v	0.45 % of measured value	0.12 % of measured value
	Repeatability ³⁾	0.23 % of measured value	0.06 % of measured value
Density	Accuracy ²⁾	4 g/l (0.25 lb/ft ³)	0.5 g/l (0.03 lb/ft ³)
	Repeatability ³⁾	2 g/l (0.13 lb/ft ³)	0.3 g/l (0.02 lb/ft ³)
Temperature	Accuracy ²⁾	1.0 °C (1.8 °F)	1.0 °C (1.8 °F)

Achievable accuracies for gases

Measured quantity		Accuracy for transmitters	
		Essential	Ultimate
Mass flow / standard volume flow ¹⁾	Accuracy ²⁾ D_{flat}	0.75 % of measured value	0.35 % of measured value
	Repeatability ³⁾	0.6 % of measured value	0.28 % of measured value
Temperature	Accuracy ²⁾	1.0 °C (1.8 °F)	1.0 °C (1.8 °F)

¹⁾ Based on the measured values of the pulse output. This means that the flow accuracy and repeatability considers the combined measurement uncertainties including sensor, electronic and pulse output interface.

²⁾ Best mass flow accuracy per transmitter type.

³⁾ The stated repeatability is included in the accuracy.

3.2 Zero point stability of the mass flow

In case of no flow, the maximum measured flow rate is called *Zero point stability*. Zero point values are shown in the table below.

Meter size	Zero point stability Z in kg/h (lb/h)
Prime 25	0.032 (0.071)
Prime 40	0.09 (0.21)
Prime 50	0.40 (0.88)
Prime 80	2.55 (5.60)
Prime 1H	8.5 (19.0)

3.3 Mass flow accuracy

Above mass flow Q_{flat} , maximum deviation is constant and referred to as D_{flat} . It depends on the product version and can be found in the tables in chapter *Accuracy of mass flow and density according to the model code* [▶ 15].

Use the following formulas to calculate the maximum deviation D :

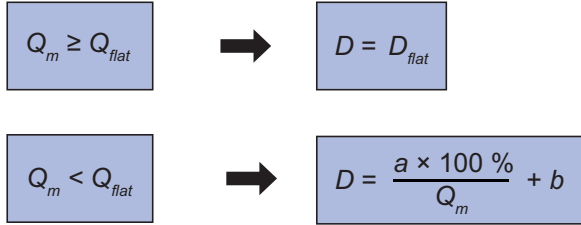

- | | | | |
|------------|--|------------|---|
| D | Maximum deviation in % | Q_m | Mass flow in kg/h |
| D_{flat} | Maximum deviation for high flow rates in % | Q_{flat} | Mass flow value above which D_{flat} applies, in kg/h |
| a, b | Constants | | |

Meter size (Q_{nom} in kg/h)	Model code position 9	D_{flat} in %	Q_{flat} in kg/h	a in kg/h	b in %
Prime 25 (1600)	E2, E3, E7	0.2	54	0.079	0.055
	D2, D3, D7	0.15	64	0.051	0.070
	C2, C3, C7	0.1	80	0.036	0.056
	70	0.75	54	0.079	0.605
	50	0.5	64	0.051	0.420
	30	0.35	80	0.036	0.306
Prime 40 (4700)	E2, E3, E7	0.2	155	0.240	0.046
	D2, D3, D7	0.15	188	0.150	0.070
	C2, C3, C7	0.1	235	0.100	0.056
	70	0.75	155	0.240	0.596
	50	0.5	188	0.150	0.420
	30	0.35	235	0.104	0.306
Prime 50 (20000)	E2, E3, E7	0.2	670	0.990	0.052
	D2, D3, D7	0.15	800	0.640	0.070
	C2, C3, C7	0.1	1000	0.440	0.056
	70	0.75	670	0.990	0.602
	50	0.5	800	0.640	0.420
	30	0.35	1000	0.444	0.306
Prime 80 (51000)	E2, E3, E7	0.2	2040	4.100	0.000
	D2, D3, D7	0.15	2300	3.300	0.008
	C2, C3, C7	0.1	2550	2.800	-0.011
	70	0.75	2040	4.100	0.550
	50	0.5	2300	3.300	0.358
	30	0.35	2550	2.833	0.239
Prime 1H (170000)	E3, E7	0.2	6800	14.000	0.000
	D3, D7	0.15	7650	11.000	0.007
	C3, C7	0.1	8500	9.400	-0.011
	70	0.75	6800	14.000	0.550
	50	0.5	7650	11.000	0.357
	30	0.35	8500	9.444	0.239

Accuracy using water at 20 °C
as an example

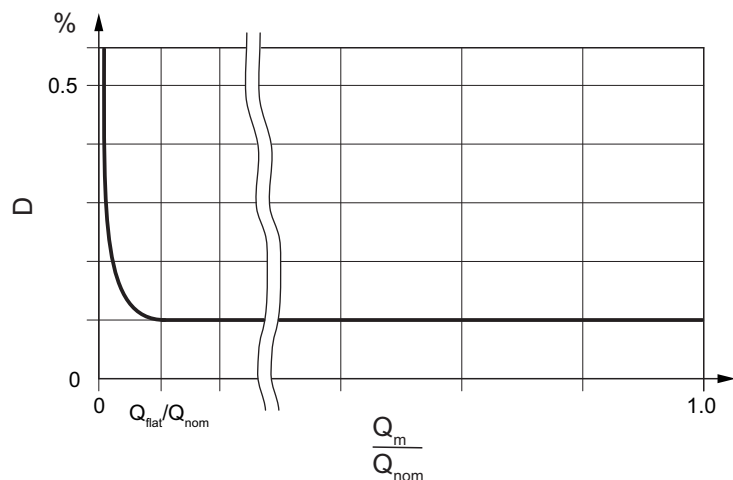

Fig. 4: Schematic dependency of the maximum deviation on the mass flow

D	Maximum deviation in %	Q_m	Mass flow in kg/h
Q_{nom}	Nominal mass flow in kg/h	Q_{flat}	Mass flow above which D_{flat} applies, in kg/h

3.4 Accuracy of density

3.4.1 For liquids

Meter size	Transmitter	Maximum deviation of density ¹⁾ in g/l (lb/ft ³)
Prime 25	Essential	Down to 4 (0.25)
Prime 40		
Prime 50		
Prime 80		
Prime 1H		
Prime 25	Ultimate	Down to 0.5 (0.03)
Prime 40		
Prime 50		
Prime 80		
Prime 1H		Down to 1 (0.06)

¹⁾ Deviations possible depending on product version (type of calibration)

The maximum deviation depends on the product version selected, see also *Accuracy of mass flow and density according to the model code* [▶ 15].

3.4.2 For gases

In most applications, density at standard conditions is programmed into the transmitter and used to calculate the standard volume flow based on mass flow.

If gas pressure is a known value, after entering a reference density, the transmitter is able to calculate gas density from temperature and pressure as well (while assuming an ideal gas).

Alternatively, gas density can be measured. In order to do so, it is necessary to adapt the lower density limit value in the transmitter.

For most applications the direct measurement of the gas density will have less accuracy as stated for liquids.

3.5 Accuracy of mass flow and density according to the model code

Accuracy for flow rate as well as density is selected via model code position 9. Here a distinction is made between devices for measuring liquids and devices for measuring gases. No accuracy for density measurement is specified for gas measurement devices.

3.5.1 For liquids

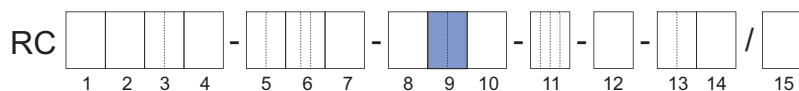

Essential

Model code position 9	Maximum deviation of density ¹⁾ in g/l	Maximum deviation D_{flat} for mass flow in %				
		Prime 25	Prime 40	Prime 50	Prime 80	Prime 1H
E7	4	0.2	0.2	0.2	0.2	0.2

¹⁾ Specified maximum deviation is achieved within the applicable measuring range for density.

Ultimate

Model code position 9	Maximum deviation of density ¹⁾ in g/l	Maximum deviation D_{flat} for mass flow in %				
		Prime 25	Prime 40	Prime 50	Prime 80	Prime 1H
E7	4	0.2	0.2	0.2	0.2	0.2
E3	1	0.2	0.2	0.2	0.2	0.2
E2 ^{2),3)}	0.5	0.2	0.2	0.2	0.2	–
D7	4	0.15	0.15	0.15	0.15	0.15
D3 ^{2),3)}	1	0.15	0.15	0.15	0.15	0.15
D2 ^{2),3)}	0.5	0.15	0.15	0.15	0.15	–
C7 ²⁾	4	0.1	0.1	0.1	0.1	0.1
C3 ²⁾	1	0.1	0.1	0.1	0.1	0.1
C2 ^{2),3)}	0.5	0.1	0.1	0.1	0.1	–

¹⁾ Specified maximum deviation is achieved within the applicable measuring range for density.

²⁾ Notice: In case of a spare sensor combined with a transmitter in use, the original accuracy specification may be affected. For calibration services, please contact Yokogawa Service department.

³⁾ Specified deviation of density is achieved within the following limits, see table below:

	Limits for density specific D_{flat} for mass flow			
	Prime 25	Prime 40	Prime 50	Prime 80
Q_{min} of C2 in kg/h	160	470	700	
Ambient temperature range in °C (°F)	-10 – 50 (14 – 122)			

3.5.2 For gases

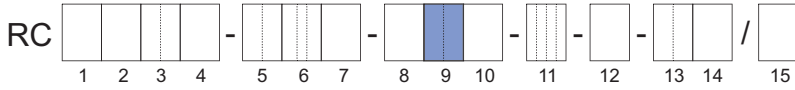

Essential

Model code position 9	Maximum deviation D_{flat} for mass flow in %
70	0.75

Ultimate

Model code position 9	Maximum deviation D_{flat} for mass flow in %
50 ¹⁾	0.5
30 ¹⁾	0.35

¹⁾ Notice: In case of a spare sensor combined with a transmitter in use, the original accuracy specification may be affected. For calibration services, please contact Yokogawa Service department.

3.6 Volume flow accuracy

3.6.1 For liquids

The following formula can be used to calculate the accuracy of liquid volume flow:

$$D_v = \sqrt{D^2 + \left(\frac{\Delta\rho}{\rho} \times 100\%\right)^2}$$

- D_v Maximum deviation of volume flow in %
- $\Delta\rho$ Maximum deviation of density in kg/l
- D Maximum deviation of mass flow in %
- ρ Density in kg/l

3.6.2 For gases

Accuracy of standard volume flow for gas with a fixed reference density equals the maximum deviation D of the mass flow.

$$D_v = D$$



The specified accuracy is then only valid for reference gas density. Gas composition changes can have different reference density leading to accuracy deviation.

3.7 Accuracy of temperature

Accuracy of temperature depends on the sensor temperature range selected (see *Process fluid temperature range [▶ 9]*) and can be calculated as follows:

Formula for specified temperature range Standard

$$\Delta T = 1.0 \text{ }^\circ\text{C} + 0.0075 \times |T_{\text{pro}} - 20 \text{ }^\circ\text{C}|$$

ΔT Maximum deviation of temperature

T_{pro} Process fluid temperature in $^\circ\text{C}$ measured by Rotamass Total Insight

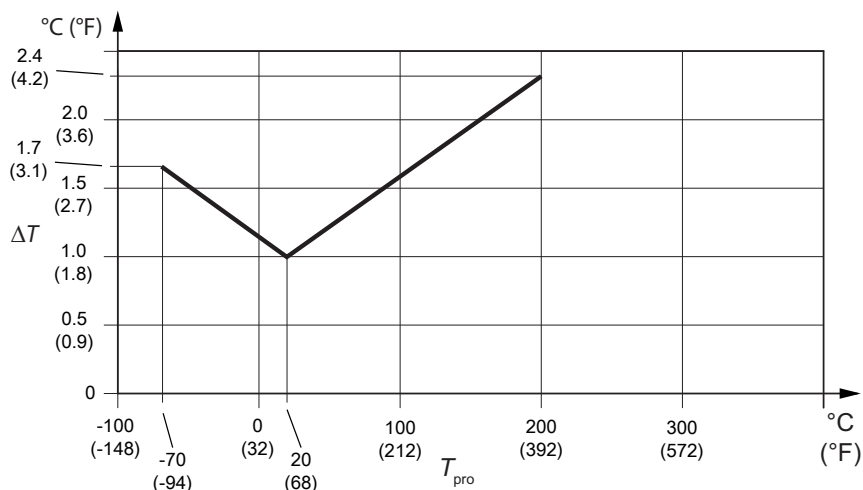

Fig. 5: Temperature accuracy

3.8 Repeatability

For liquids

When using default damping times, the specified repeatability of mass flow, density and temperature measurements equals half of the respective maximum deviation.

$$R = \frac{D}{2}$$

R Repeatability

D Maximum deviation

For gases

In deviation hereto, the following applies to mass and standard volume flow of gases:

$$R = \frac{D}{1.25}$$

3.9 Calibration conditions

3.9.1 Mass flow calibration and density adjustment

The calibration laboratory at Rota Yokogawa is accredited according to DIN EN ISO/IEC 17025:2018. All Rotamass are calibrated in accordance with standard calibration procedure and each device comes with a standard calibration certificate. Optionally, a 5 point-calibration (option K2) or a 10 point-calibration with DAkkS calibration certificate (option K5) can be performed .

Each Rotamass device comes with a standard calibration certificate.

Calibration takes place at reference conditions. Specific values are listed in the standard calibration certificate.

	Reference conditions
Fluid	Water
Density	0.9 – 1.1 kg/l (56 – 69 lb/ft ³)
Fluid temperature	10 – 35 °C (50 – 95 °F) Average temperature: 22,5 °C (72.5 °F)
Ambient temperature	10 – 35 °C (50 – 95 °F)
Process pressure (absolute)	1 – 5 bar (15 – 73 psi)

The accuracy specified is achieved at as-delivered calibration conditions stated.

3.9.2 Density calibration

Density calibration is performed for maximum deviation of 0.5 g/l (0.03 lb/ft³), (model code pos. 9: C2 or D2).

Density calibration includes:

- Determination of calibration constants for fluid densities at 0.7 kg/l (44 lb/ft³), 1 kg/l (62 lb/ft³) and 1.65 kg/l (103 lb/ft³) at 20 °C (68 °F) fluid temperature
- Check of results for fluid densities at 0.7 kg/l (44 lb/ft³), 1 kg/l (62 lb/ft³) and 1.65 kg/l (103 lb/ft³) at 20 °C (68 °F) fluid temperature
- Creation of density calibration certificate

3.9.3 Calibration for gases

Same calibration conditions described in *Mass flow calibration and density adjustment* [▶ 18] apply for gas measurement according to AGA11 water calibration transferability¹⁾. Specifications are determined based on evaluation at accredited ISO/IEC17025 calibration at following conditions:

Terms	Reference conditions
Fluid	Natural Gas
Fluid temperature	20 °C (68 °F)
Process pressure	16 barg (232 psig) and 50 barg (725 psig)

Different gases can be considered by entering characteristic gas sound velocity and related temperature coefficient¹⁾.

¹⁾ Only with Rotamass Total Insight HART firmware rev.4 or later. For details please contact your local Yokogawa sales organization.

3.10 Process conditions



For process specific results, please refer to the FlowConfigurator online sizing and configuration tool: <http://www.FlowConfigurator.com>

3.10.1 Process pressure effect

Process pressure effect is defined as the change in sensor flow and density deviation due to process pressure change away from 1 barg reference condition. This effect can be corrected by dynamic pressure input or a fixed process pressure.

Tab. 3: Process pressure effect

Meter size	Deviation of Flow		Deviation of Density	
	in % of rate per bar	in % of rate per psi	in g/l per bar	in g/l per psi
Prime 25	-0.0020	-0.00014	-0.021	-0.0015
Prime 40	-0.0084	-0.00058	-0.151	-0.0104
Prime 50	-0.0109	-0.00075	-0.073	-0.0050
Prime 80	-0.0130	-0.0009	-0.091	-0.0063
Prime 1H	-0.0233	-0.00161	-0.120	-0.0083

3.10.2 Process fluid temperature effect

For mass flow and density measurement, process fluid temperature effect is defined as the change in sensor flow and density accuracy due to process fluid temperature change away from 20°C reference condition. For temperature ranges, see *Process fluid temperature range* [9].

Temperature effect on Zero

Temperature effect on Zero of mass flow can be corrected by zeroing at the process fluid temperature.

Temperature effect on mass flow

The process fluid temperature is measured and the temperature effect compensated. However due to uncertainties in the compensation coefficients and in the temperature measurement an uncertainty of this compensation is left. The typical rest error of Rotamass Total Insight temperature effect on mass flow is:

Tab. 4: All models

Temperature range	Uncertainty of flow
Standard	± 0.0009 % of rate / °C (± 0.0005 % of rate / °F)

The temperature used for calculation of the uncertainty is the difference between process fluid temperature and the temperature 20°C reference condition.

Temperature effect on density measurement (liquids)

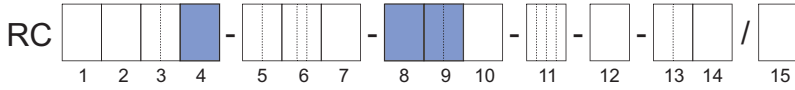

Process fluid temperature influence:

Formula for metric values

$$D'_\rho = \pm k \times \text{abs}(T_{\text{pro}} - 20 \text{ }^\circ\text{C})$$

Formula for imperial values

$$D'_\rho = \pm k \times \text{abs}(T_{\text{pro}} - 68 \text{ }^\circ\text{F})$$

- D'_ρ Additional density deviation due to the effect of fluid temperature in g/l (lb/ft³)
- T_{pro} Process fluid temperature in °C measured by Rotamass Total Insight
- k Constant for temperature effect on density measurement in g/l × 1/°C (lb/ft³ × 1/°F)

Tab. 5: Constants for particular meter size and model code position (see also *Process fluid temperature range* [9] and *For liquids* [15])

Meter size	Model code position 4	Model code position 8	Model code position 9	k in g/l × 1/°C (lb/ft ³ × 1/°F)
Prime 25	S	0	C3, C7, D3, D7, E3, E7	0.21 (0.0073)
			C2, D2, E2	0.041 (0.0014)
Prime 40			C3, C7, D3, D7, E3, E7	0.14 (0.0049)
			C2, D2, E2	0.027 (0.0009)
Prime 50			C3, C7, D3, D7, E3, E7	0.12 (0.0042)
			C2, D2, E2	0.025 (0.0009)
Prime 80			C3, C7, D3, D7, E3, E7	0.13 (0.0045)
			C2, D2, E2	0.025 (0.0009)
Prime 1H			C3, C7, D3, D7, E3, E7	0.12 (0.0042)

3.11 Analog output specification

Analog output specification *I_{out}*

If mass- or volume flow, density, temperature, pressure or concentration is measured via current output *I_{out}* two additional deviation effects have to be taken into account.

- The *I_{out}* –base specification ΔI_{base} contains all combined effects of output adjustment, linearity, power supply variation, load resistance variation, short and long term drift for one year.
- The *I_{out}* –ambient temperature specification $\Delta I(T_{\text{amb}})$ gives an additional deviation effect if the ambient temperature of the transmitter differs from 20 °C.

Both additional output deviation effects have to be added to the basic mass- or volume flow, density, temperature, pressure or concentration deviation. They are based on a 95 % (2σ) confidence level.

Deviation of mass- or volume flow, density, temperature, pressure or concentration by *I_{out}*

The following formula can be used to calculate the deviation of mass- or volume flow:

$$D_i = \sqrt{D^2 + \left(\frac{\Delta I_{\text{base}}}{I(Q)} \times 100 \% \right)^2 + \left(\frac{\Delta I(T_{\text{amb}})}{I(Q)} \times 100 \% \right)^2}$$

D_i	Maximum deviation of mass- or volume flow, density, temperature, pressure or concentration by <i>I_{out}</i> in %
D	Maximum deviation of mass- or volume flow, density, temperature, pressure or concentration ¹⁾ by pulse/frequency output in %
$I(Q)$	<i>I_{out}</i> depending on mass- or volume flow, density, temperature, pressure or concentration in μA
ΔI_{base}	Maximum deviation of <i>I_{out}</i> by combined effects $\Delta I_{\text{base}} = a \times I(Q) + b$
$\Delta I(T_{\text{amb}})$	Maximum deviation of <i>I_{out}</i> by deviation of the transmitter ambient temperature from 20 °C $\Delta I(T_{\text{amb}}) = (c \times I(Q) + d) \times (T - 20 \text{ °C})$
a, b, c, d	Constants

Description	Model code pos. 13	a in ppm	b in μA	c in ppm/°C	d in $\mu\text{A}/\text{°C}$
Non-intrinsically safe <i>I_{out}</i> (active or passive)	JA, JB, JC, JD, JE, JF, JG, JH, JJ, JK, JL, JM, JN, M6	170	2.3	7	0
Intrinsically safe <i>I_{out}</i> (passive)	JP, JQ, JR, JS				0.06

¹⁾Formula or value for accuracy of specific output parameter, please see chapters:

- 3.4 Accuracy of density [▶ 14]
- 3.6 Volume flow accuracy [▶ 16]
- 3.7 Accuracy of temperature [▶ 17]

4 Operating conditions

4.1 Location and position of installation

Rotamass Coriolis flow meters can be mounted horizontally, vertically and at an incline. The measuring tubes should be completely filled with the fluid during flow measurement as accumulations of air or formation of gas bubbles in the measuring tube may result in errors in measurement. Straight pipe runs at inlet or outlet are usually not required.

Avoid the following installation locations and positions:

- Measuring tubes as highest point in piping when measuring liquids
- Measuring tubes as lowest point in piping when measuring gases
- Immediately in front of a free pipe outlet in a downpipe
- Lateral positions

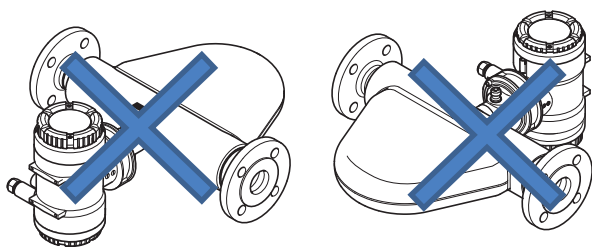
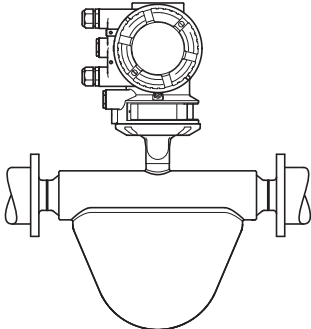
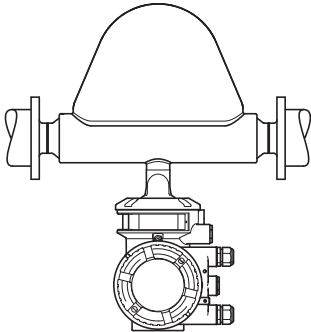
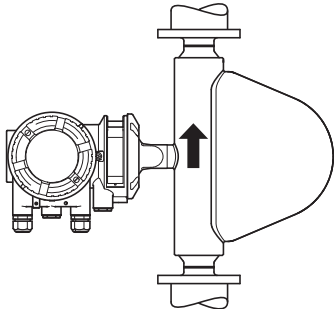

Fig. 6: Installation position to be avoided: Flow meter in sideways position

4.1.1 Sensor installation position

Sensor installation position as a function of the fluid

Installation position	Fluid	Description
Horizontal, measuring tubes at bottom 	Liquid	The measuring tubes are oriented toward the bottom. Accumulation of gas bubbles is avoided.
Horizontal, measuring tubes at top 	Gas	The measuring tubes are oriented toward the top. Accumulation of liquid, such as condensate is avoided.
Vertical, direction of flow towards the top (recommended) 	Liquid/gas	The sensor is installed on a pipe with the direction of flow towards the top. Accumulation of gas bubbles or solids is avoided. This position allows for complete self-draining of the measuring tubes.

4.2 Process conditions



The pressure and temperature ratings presented in this section represent the design values for the devices. For individual applications (e.g. marine applications with option MC_) further limitations may apply according to the respective applicable regulations. For details see chapter *Application and industry related standards* [▶ 80] under the heading Marine approvals.



In this chapter, all values related to pressure are gauge pressure values.

4.2.1 Pressure

The maximum allowed process pressure depends on the selected process connection and process temperature.

The given process temperature and process pressure ranges are calculated and approved without corrosion or erosion effects.

The following diagrams shows the process pressure as a function of process temperature as well as the process connection used (type and size of process connection).

Calculations for ASME flanges are based on ASME B16.5 Material group 2.2 (316/316L dual certified).

ASME class 150, JPI class 150

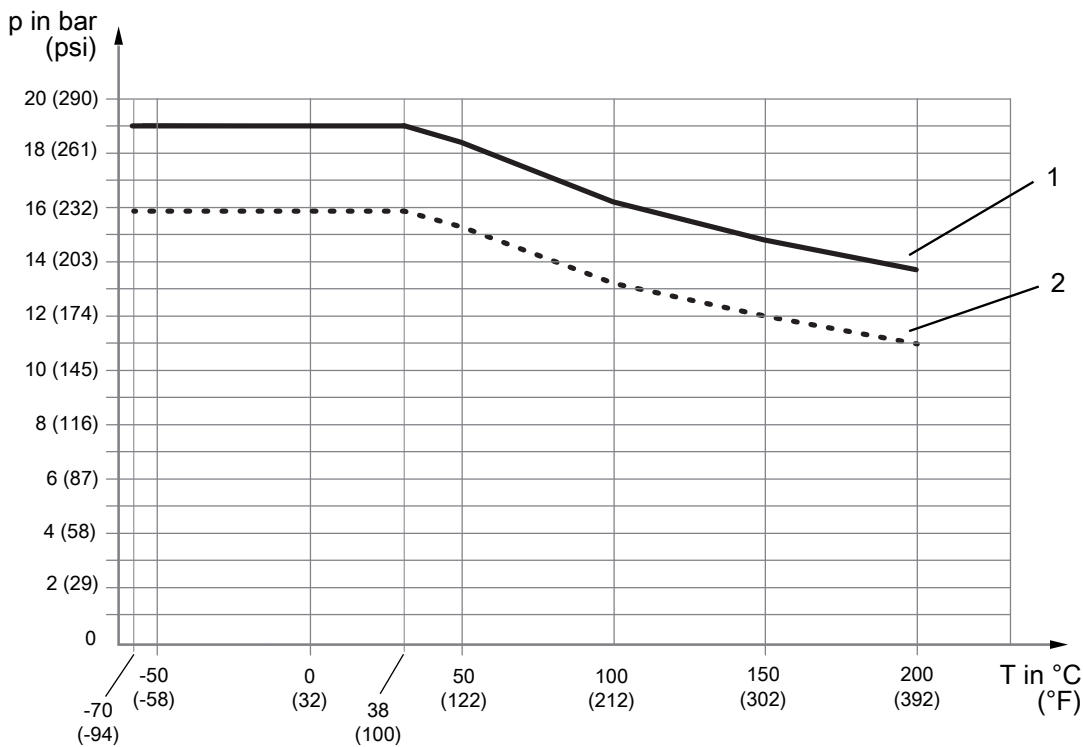

Fig. 7: Allowed process pressure as a function of process connection temperature

- 1 Process connection compatible to ASME B16.5 class 150
- 2 Process connection compatible to JPI class 150

ASME class 300, EN PN40, JPI class 300

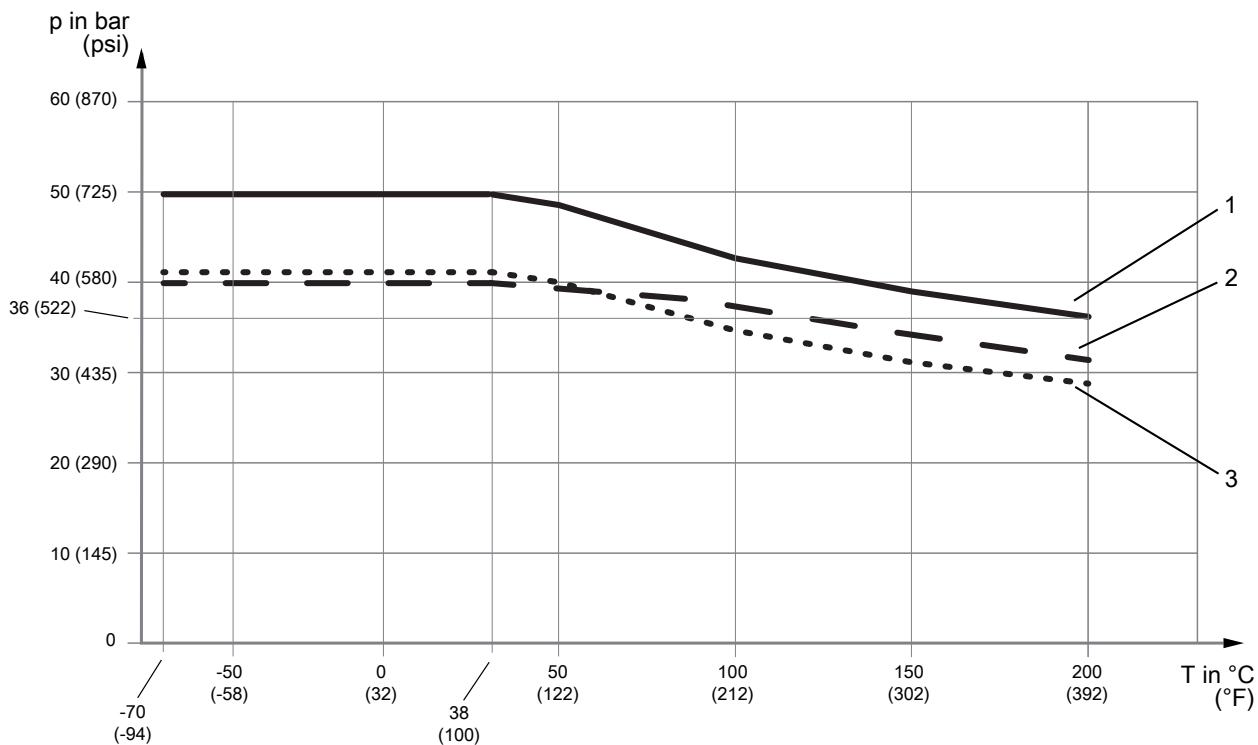

Fig. 8: Allowed process pressure as a function of process fluid temperature

- 1 Process connection compatible to ASME B16.5 class 300
- 2 Process connection compatible to EN 1092-1 PN40
- 3 Process connection compatible to JPI class 300

ASME class 600, JPI class 600

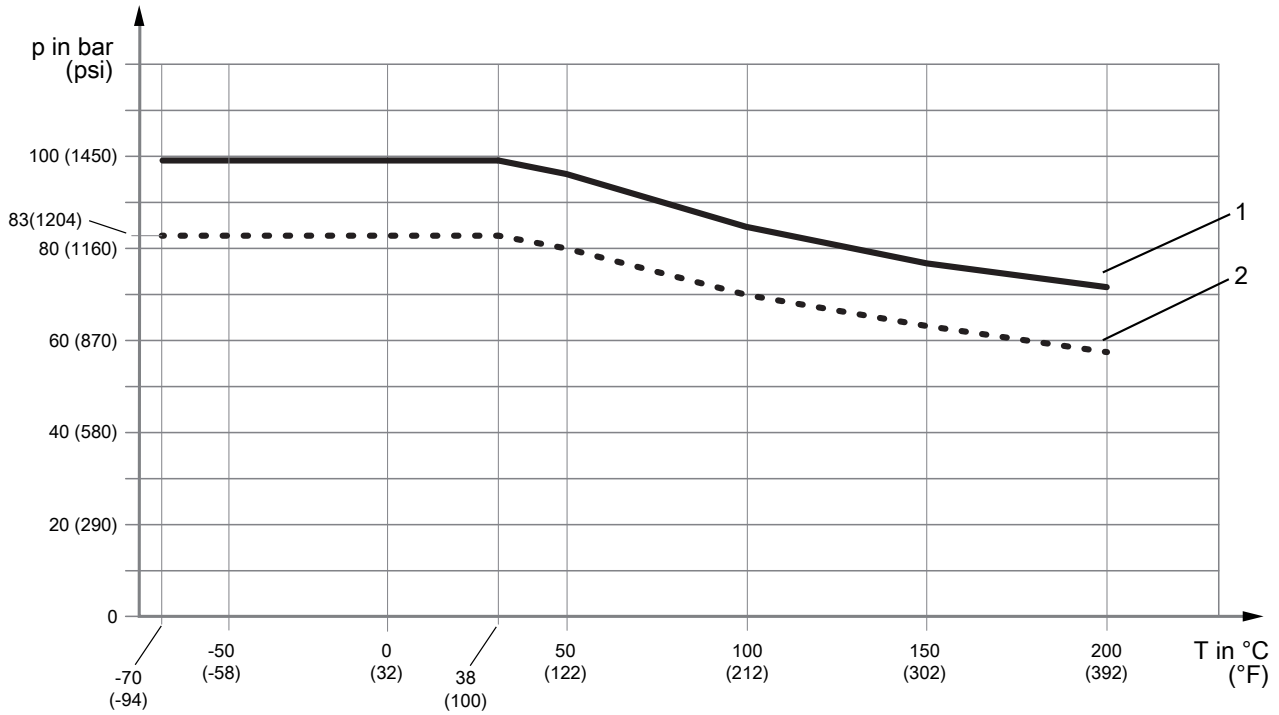

Fig. 9: Allowed process pressure as a function of process connection temperature

- 1 Process connection compatible to ASME B16.5 class 600
- 2 Process connection compatible to JPI class 600

EN PN100

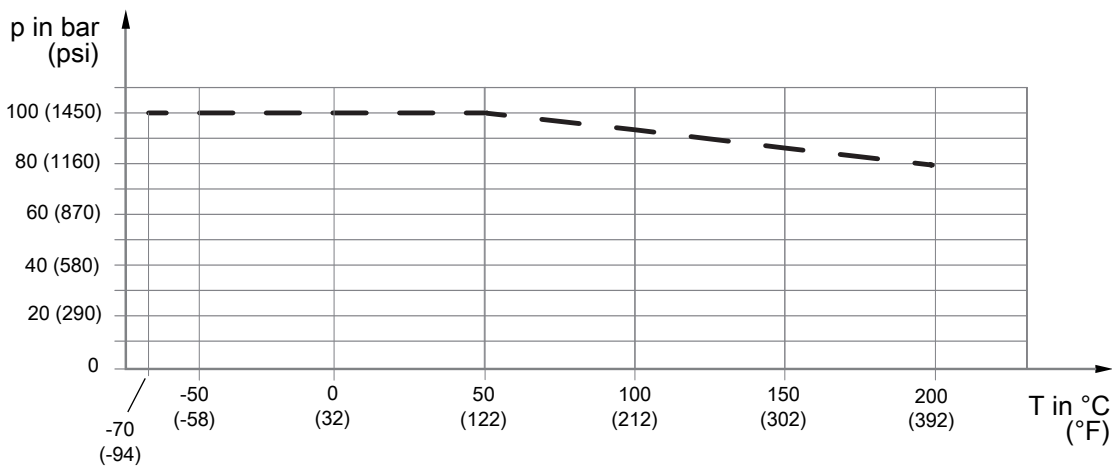

Fig. 10: Allowed process pressure as a function of process fluid temperature, compatible to flange EN 1092-1 PN100

JIS 10K, JIS 20K

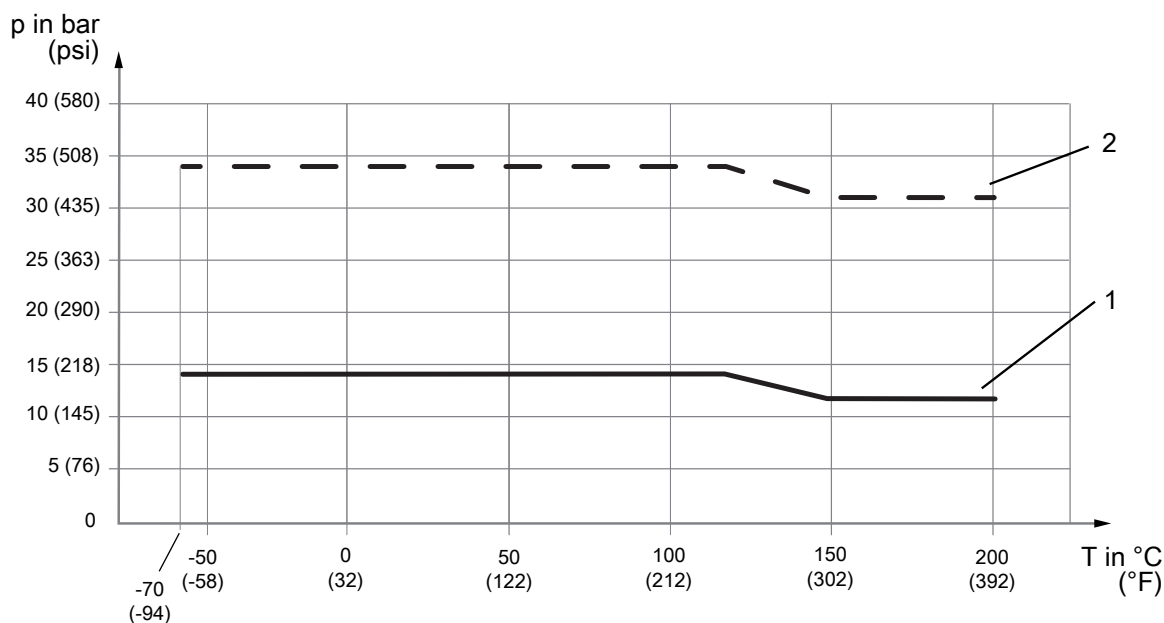

Fig. 11: Allowed process pressure as a function of process fluid temperature

- 1 Process connection compatible to JIS B 2220 10K
- 2 Process connection compatible to JIS B 2220 20K

Process connection with internal thread G and NPT

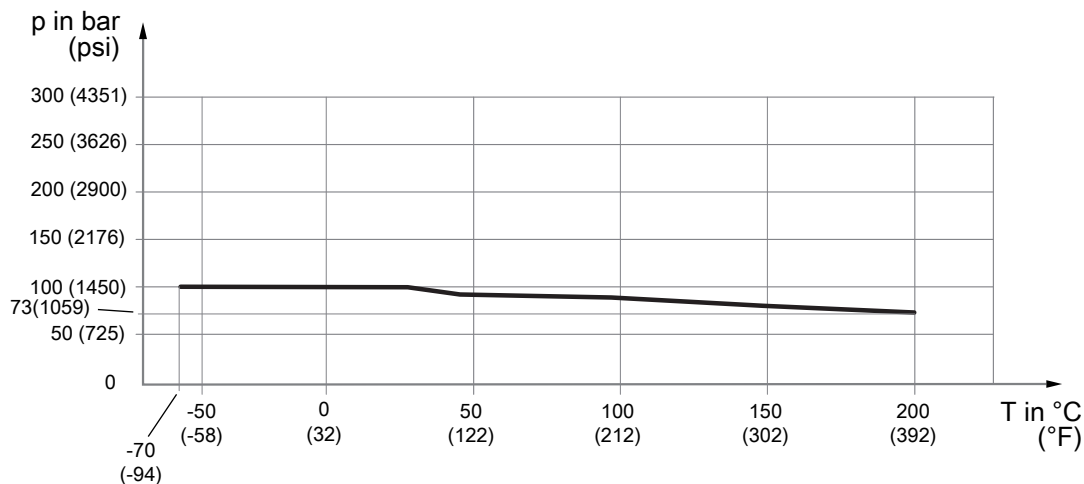

Fig. 12: Allowed process pressure as a function of process fluid temperature

4.2.2 Secondary containment

Some applications or environment conditions require secondary containment retaining the process pressure for increased safety. All Rotamass Total Insight have a secondary containment filled with inert gas. The typical burst pressure values of the secondary housing are defined in the table below.

Typical burst pressure at room temperature

Burst pressure in bar (psi)				
Prime 25	Prime 40	Prime 50	Prime 80	Prime 1H
49 (710)				30 (435)

4.3 Ambient conditions

Allowed ambient and storage temperature of Rotamass Total Insight depends on the below components and their own temperature limits:

- Sensor
- Transmitter
- Connecting cable between sensor and transmitter (for remote design type)

Ambient temperature

Device surrounding air temperature is considered as ambient temperature. If the device is operating outdoors make sure that the solar irradiation does not increase the surface temperature of the device higher than the allowed maximum ambient temperature. Transmitter display has limited legibility below -20 °C (-4 °F).

Maximum ambient temperature range		
integral type:		-40 – 60 °C (-40 – 140 °F)
remote type		
with standard cable (option L _{xxx}):	Sensor ¹⁾ :	-50 – 80 °C (-58 – 176 °F)
	Transmitter:	-40 – 60 °C (-40 – 140 °F)
with fire retardant cable ²⁾ (option Y _{xxx}):	Sensor ¹⁾ :	-35 – 80 °C (-31 – 176 °F)
	Transmitter:	-35 – 60 °C (-31 – 140 °F)

Ambient temperature range for NTEP custody transfer approval

Maximum ambient temperature range (/Q20)		
integral type:		-40 – 50 °C(-40 – 122 °F)
remote type		
with standard cable (option L _{xxx}):	Sensor ¹⁾ :	-50 – 80 °C(-58 – 176 °F)
	Transmitter:	-40 – 50 °C (-40 – 122 °F)
with fire retardant cable ²⁾ (option Y _{xxx}):	Sensor ^{1), 2)} :	-35 – 80 °C(-31 – 176 °F)
	Transmitter:	-35 – 50 °C (-31 – 122 °F)

¹⁾ Check derating for high fluid temperature, see *Process fluid temperature range* [▶ 9], *Process conditions* [▶ 24] and *Allowed ambient temperature for sensor* [▶ 29]

²⁾ Lower temperature specification valid for fixed installation only

Storage temperature

Maximum storage temperature range		
integral type		-40 – 60 °C (-40 – 140 °F)
remote type		
with standard cable (option L _{xxx}):	Sensor:	-50 – 80 °C (-58 – 176 °F)
	Transmitter:	-40 – 60 °C (-40 – 140 °F)
with fire retardant cable (option Y _{xxx}):	Sensor:	-35 – 80 °C (-31 – 176 °F)
	Transmitter:	-35 – 60 °C (-31 – 140 °F)

Further ambient conditions

Ranges and specifications	
Relative humidity	0 – 95 %
IP code	IP66/67 for transmitters and sensors when using the appropriate cable glands
Allowable pollution degree in surrounding area acc. EN 61010-1	4 (in operation)
Vibration resistance acc. IEC 60068-2-6	Transmitter: 10 – 500 Hz, 1g Sensor: 10 – 500 Hz, 1g
Electromagnetic compatibility (EMC) <ul style="list-style-type: none"> ▪ IEC/EN 61326-1, Table 2 ▪ IEC/EN 61326-2-3 ▪ IEC/EN 61326-2-5 ▪ NAMUR NE 21 recommendation ▪ DNV-CG-0339 Section 3, Chapter 14 This includes <ul style="list-style-type: none"> ▪ Surge immunity acc.: <ul style="list-style-type: none"> – EN 61000-4-5 for lightning protection ▪ Emission acc.: <ul style="list-style-type: none"> – IEC/EN 61000-3-2, Class A – IEC/EN 61000-3-3, Class A – NAMUR NE 21 recommendation – DNV-CG-0339 Section 3, Chapter 14 	Immunity assessment criterion: The output signal fluctuation is within ±1 % of the output span.
Maximum altitude	2000 m (6600 ft) above mean sea level (MSL)
Overvoltage category according to IEC/EN 61010-1	II

4.3.1 Allowed ambient temperature for sensor

The allowed ambient temperature of the sensor depends on the following product properties:

- Process fluid temperature, see *Process fluid temperature range* [▶ 9]
- Design type
 - Integral type
 - Remote type
- Connecting cable type (options L_{xxx} and Y_{xxx})

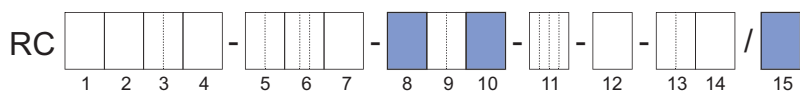

The allowed combinations of process fluid and ambient temperature for the sensor are illustrated as gray areas in the diagrams below.



Allowed process fluid and ambient temperature ranges in hazardous areas depend on classifications defined by applications, refer to *Temperature specification in hazardous areas* [▶ 31].

Temperature range specification Standard, integral type

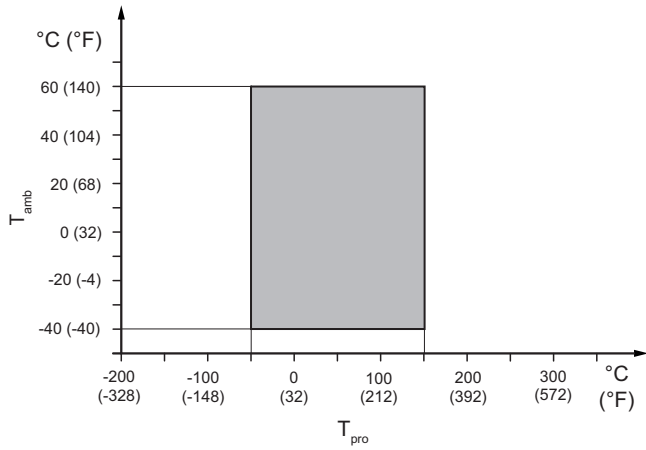

Fig. 13: Allowed process fluid and ambient temperatures, integral type

T_{amb} Ambient temperature
 T_{pro} Process fluid temperature

Temperature range specification Standard, remote type

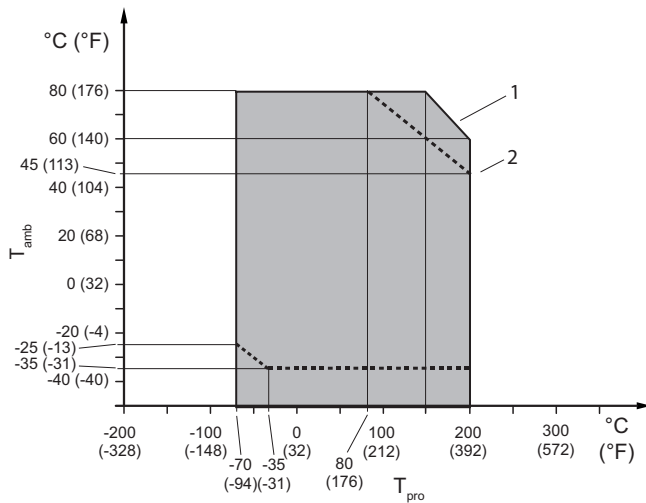

Fig. 14: Allowed process fluid and ambient temperatures, remote type

- 1 Standard cable option L_ _ _ _
- 2 Limitation for fire retardant cable option Y_ _ _ _

4.3.2 Temperature specification in hazardous areas

Please select appropriate equipment in accordance with the laws and regulations of the relevant country/region, when it is used in a location where explosive atmospheres may be present.

The maximum ambient and process fluid temperature of Integral type and Remote Sensor depending on explosion groups and temperature classes are related to different characteristics:

- Size of the sensor (model code Pos.3)
- Design and housing (model code Pos.10)
- Type of EX approval (model code Pos.11)
- Enhanced process fluid temperature (model code Pos.15: option “EPT”)

Model code:

Pos. 2: P

Pos. 3: 25, 40

Pos. 10: 0, 2

Pos. 11: _F21, _F22, FF11, FF12

Pos. 15: –

Ex code: 7.66.66.68.54.10

The following figure shows the relevant positions of the model code:

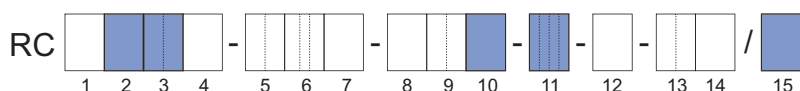

Tab. 6: Temperature classification

Temperature class	Maximum ambient temperature in °C (°F)	Maximum process fluid temperature in °C (°F)
T6	43 (109)	47 (116)
T5	58 (136)	62 (143)
T4	60 (140)	99 (210)
T3	60 (140)	150 (302)
T2	60 (140)	150 (302)
T1	60 (140)	150 (302)

Model code:

Pos. 2: P

Pos. 3: 25, 40

Pos. 10: 0, 2

Pos. 11: JF54, JF53

Ex code:

–

The following figure shows the relevant positions of the model code:

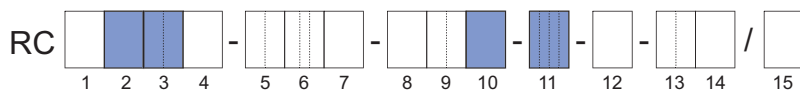

Tab. 7: Temperature classification

Temperature class	Maximum ambient temperature in °C	Maximum process fluid temperature in °C
T4	60	99
T3	60	150

Model code:

Pos. 2: P

Pos. 3: 25, 40

Pos. 10: 0, 2

Pos. 11: _F21, _F22, FF11, FF12

Pos. 15: EPT

Ex code: 1.83.83.84.54.10

The following figure shows the relevant positions of the model code:

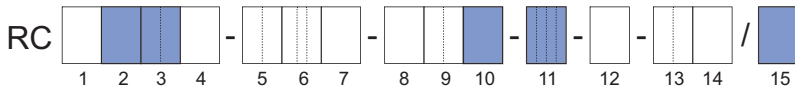

Tab. 8: Temperature classification

Temperature class	Maximum ambient temperature in °C (°F)	Maximum process fluid temperature in °C (°F)
T6	60 (140)	64 (147)
T5	60 (140)	79 (174)
T4	60 (140)	115 (239)
T3	60 (140)	150 (302)
T2	60 (140)	150 (302)
T1	60 (140)	150 (302)

Model code:

Pos. 2: P

Pos. 3: 50

Pos. 10: 0, 2

Pos. 11: _F21, _F22, FF11, FF12

Pos. 15: –

Ex code: 2.73.72.76.54.10

The following figure shows the relevant positions of the model code:

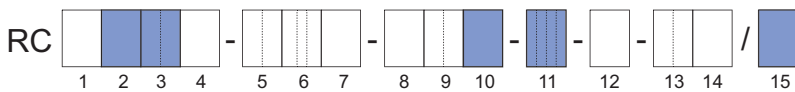

Tab. 9: Temperature classification

Temperature class	Maximum ambient temperature in °C (°F)	Maximum process fluid temperature in °C (°F)
T6	54 (129)	54 (129)
T5	60 (140)	68 (154)
T4	60 (140)	107 (224)
T3	60 (140)	150 (302)
T2	60 (140)	150 (302)
T1	60 (140)	150 (302)

Model code:

Pos. 2: P

Pos. 3: 50

Pos. 10: 0, 2

Pos. 11: JF54, JF53

Ex code:

-

The following figure shows the relevant positions of the model code:

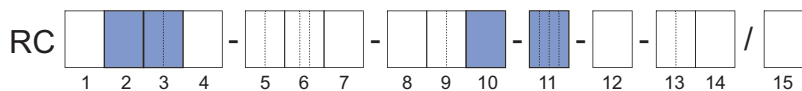

Tab. 10: Temperature classification

Temperature class	Maximum ambient temperature in °C	Maximum process fluid temperature in °C
T4	60	107
T3	60	150

Model code:

Pos. 2: P

Pos. 3: 50

Pos. 10: 0, 2

Pos. 11: _F21, _F22, FF11, FF12

Pos. 15: EPT

Ex code: 1.91.91.91.54.10

The following figure shows the relevant positions of the model code:

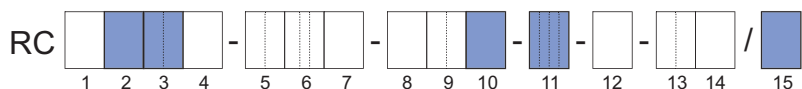

Tab. 11: Temperature classification

Temperature class	Maximum ambient temperature in °C (°F)	Maximum process fluid temperature in °C (°F)
T6	60 (140)	72 (161)
T5	60 (140)	87 (188)
T4	60 (140)	122 (251)
T3	60 (140)	150 (302)
T2	60 (140)	150 (302)
T1	60 (140)	150 (302)

Model code:

Pos. 2: P

Pos. 3: 80

Pos. 10: 0, 2

Pos. 11: _F21, FF11

Pos. 15: –

Ex code: 7.83.84.86.54.10

The following figure shows the relevant positions of the model code:

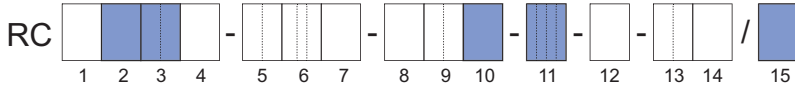

Tab. 12: Temperature classification

Temperature class	Maximum ambient temperature in °C (°F)	Maximum process fluid temperature in °C (°F)
T6	40 (104)	64 (147)
T5	55 (131)	80 (176)
T4	60 (140)	117 (242)
T3	60 (140)	150 (302)
T2	60 (140)	150 (302)
T1	60 (140)	150 (302)

Model code:

Pos. 2: P

Pos. 3: 80

Pos. 10: 0, 2

Pos. 11: _F22, FF12

Pos. 15: –

Ex code: 6.83.84.86.54.10

The following figure shows the relevant positions of the model code:

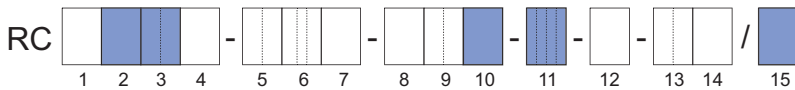

Tab. 13: Temperature classification

Temperature class	Maximum ambient temperature in °C (°F)	Maximum process fluid temperature in °C (°F)
T6	44 (111)	64 (147)
T5	59 (138)	80 (176)
T4	60 (140)	117 (242)
T3	60 (140)	150 (302)
T2	60 (140)	150 (302)
T1	60 (140)	150 (302)

Model code:

Pos. 2: P

Pos. 3: 80

Pos. 10: 0, 2

Pos. 11: JF54, JF53

Ex code:

–

The following figure shows the relevant positions of the model code:

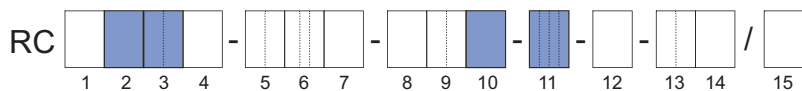

Tab. 14: Temperature classification

Temperature class	Maximum ambient temperature in °C	Maximum process fluid temperature in °C
T4	60	117
T3	60	150

Model code:

Pos. 2: P

Pos. 3: 1H

Pos. 10: 0, 2

Pos. 11: _F21, _F22, FF11, FF12

Pos. 15: –

Ex code:

7.87.87.88.54.10

The following figure shows the relevant positions of the Model code:

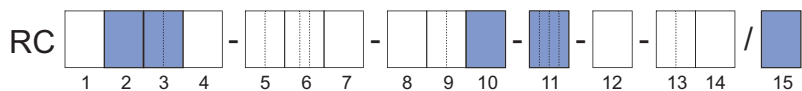

Tab. 15: Temperature classification

Temperature class	Maximum ambient temperature in °C (°F)	Maximum process fluid temperature in °C (°F)
T6	39 (102)	68 (154)
T5	54 (129)	83 (181)
T4	60 (140)	119 (246)
T3	60 (140)	150 (302)
T2	60 (140)	150 (302)
T1	60 (140)	150 (302)

Model code:

Pos. 2: P

Pos. 3: 1H

Pos. 10: 0, 2

Pos. 11: JF54, JF53

Ex code:

-

The following figure shows the relevant positions of the Model code:

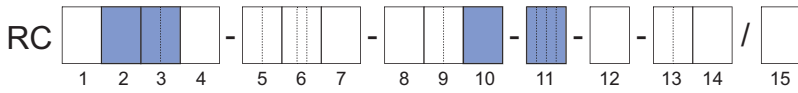

Tab. 16: Temperature classification

Temperature class	Maximum ambient temperature in °C	Maximum process fluid temperature in °C
T4	60	119
T3	60	150

Model code:

Pos. 2: P

Pos. 3: 25, 40

Pos. 10: A, E, J

Pos. 11: _F21, _F22

Pos. 15: -

Ex code: 7.66.66.68.66.60

The following figure shows the relevant positions of the model code:

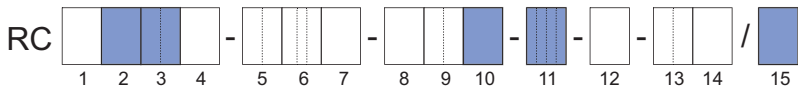

Tab. 17: Temperature classification

Temperature class	Maximum ambient temperature in °C (°F)		Maximum process fluid temperature in °C (°F)
	Option L_	Option Y_	
T6	46 (114)	46 (114)	47 (116)
T5	61 (141)	61 (141)	62 (143)
T4	80 (176)	74 (165)	99 (210)
T3	74 (165)	56 (132)	162 (323)
T2	60 (140)	46 (114)	200 (392)
T1	60 (140)	46 (114)	200 (392)

Model code:

Pos. 2: P

Pos. 3: 25, 40

Pos. 10: A, E, J

Pos. 11: FF11, FF12

Pos. 15: –

Ex code:

7.66.66.68.66.60

The following figure shows the relevant positions of the model code:

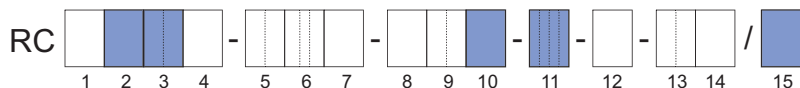

Tab. 18: Temperature classification

Temperature class	Maximum ambient temperature in °C (°F)		Maximum process fluid temperature in °C (°F)
	Option L ₀₀₀	Option Y ₀₀₀	
T6	46 (114)	46 (114)	47 (116)
T5	61 (141)	61 (141)	62 (143)
T4	80 (176)	70 (158)	99 (210)
T3	74 (165)	56 (132)	162 (323)
T2	60 (140)	46 (114)	200 (392)
T1	60 (140)	46 (114)	200 (392)

Model code:

Pos. 2: P

Pos. 3: 25, 40

Pos. 10: A, E

Pos. 11: JF54, JF53

Ex code:

–

The following figure shows the relevant positions of the model code:

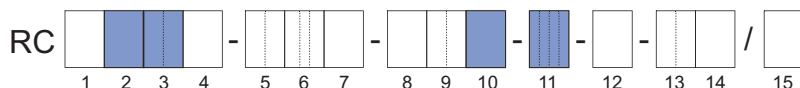

Tab. 19: Temperature classification

Temperature class	Maximum ambient temperature in °C		Maximum process fluid temperature in °C
	Option L ₀₀₀	Option Y ₀₀₀	
T4	80	–	99
T3	74	–	162

Model code:

Pos. 2: P

Pos. 3: 25, 40

Pos. 10: A, E, J

Pos. 11: _F21, _F22

Pos. 15: EPT

Ex code: 1.83.83.84.82.60

The following figure shows the relevant positions of the model code:

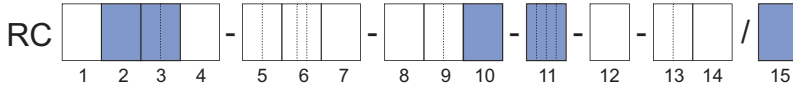

Tab. 20: Temperature classification

Temperature class	Maximum ambient temperature in °C (°F)		Maximum process fluid temperature in °C (°F)
	Option L_	Option Y_	
T6	64 (147)	64 (147)	64 (147)
T5	79 (174)	79 (174)	79 (174)
T4	80 (176)	66 (150)	115 (239)
T3	68 (154)	51 (123)	178 (352)
T2	60 (140)	46 (114)	200 (392)
T1	60 (140)	46 (114)	200 (392)

Model code:

Pos. 2: P

Pos. 3: 25, 40

Pos. 10: A, E, J

Pos. 11: FF11, FF12

Pos. 15: EPT

Ex code:

1.83.83.84.82.60

The following figure shows the relevant positions of the model code:

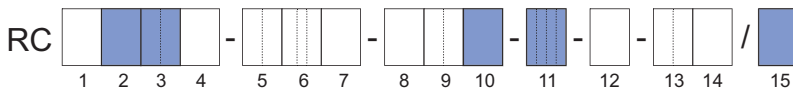

Tab. 21: Temperature classification

Temperature class	Maximum ambient temperature in °C (°F)		Maximum process fluid temperature in °C (°F)
	Option L_	Option Y_	
T6	64 (147)	64 (147)	64 (147)
T5	79 (174)	70 (158)	79 (174)
T4	80 (176)	66 (150)	115 (239)
T3	68 (154)	51 (123)	178 (352)
T2	60 (140)	46 (114)	200 (392)
T1	60 (140)	46 (114)	200 (392)

Model code:

Pos. 2: P

Pos. 3: 50

Pos. 10: A, E, J

Pos. 11: _F21, _F22, FF11, FF12

Pos. 15: –

Ex code: 2.73.72.76.80.60

The following figure shows the relevant positions of the model code:

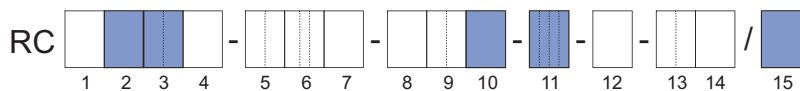

Tab. 22: Temperature classification

Temperature class	Maximum ambient temperature in °C (°F)		Maximum process fluid temperature in °C (°F)
	Option L_	Option Y_	
T6	54 (129)	54 (129)	54 (129)
T5	68 (154)	68 (154)	68 (154)
T4	80 (176)	66 (150)	107 (224)
T3	68 (154)	51 (123)	176 (348)
T2	60 (140)	46 (114)	200 (392)
T1	60 (140)	46 (114)	200 (392)

Model code:

Pos. 2: P

Pos. 3: 50

Pos. 10: A, E

Pos. 11: JF54, JF53

Ex code:

–

The following figure shows the relevant positions of the model code:

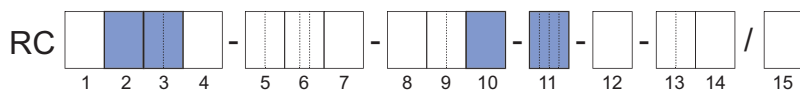

Tab. 23: Temperature classification

Temperature class	Maximum ambient temperature in °C		Maximum process fluid temperature in °C
	Option L_	Option Y_	
T4	80	–	107
T3	68	–	176

Model code:

Pos. 2: P

Pos. 3: 50

Pos. 10: A, E, J

Pos. 11: _F21, _F22

Pos. 15: EPT

Ex code: 1.91.91.91.60

The following figure shows the relevant positions of the model code:

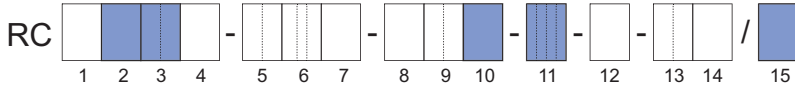

Tab. 24: Temperature classification

Temperature class	Maximum ambient temperature in °C (°F)		Maximum process fluid temperature in °C (°F)
	Option L_	Option Y_	
T6	72 (161)	72 (161)	72 (161)
T5	80 (176)	77 (170)	87 (188)
T4	80 (176)	66 (150)	122 (251)
T3	64 (147)	49 (120)	187 (368)
T2	60 (140)	46 (114)	200 (392)
T1	60 (140)	46 (114)	200 (392)

Model code:

Pos. 2: P

Pos. 3: 50

Pos. 10: A, E, J

Pos. 11: FF11, FF12

Pos. 15: EPT

Ex code:

1.91.91.91.60

The following figure shows the relevant positions of the model code:

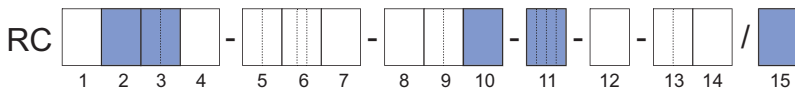

Tab. 25: Temperature classification

Temperature class	Maximum ambient temperature in °C (°F)		Maximum process fluid temperature in °C (°F)
	Option L_	Option Y_	
T6	72 (161)	70 (158)	72 (161)
T5	80 (176)	70 (158)	87 (188)
T4	80 (176)	66 (150)	122 (251)
T3	64 (147)	49 (120)	187 (368)
T2	60 (140)	46 (114)	200 (392)
T1	60 (140)	46 (114)	200 (392)

Model code:

Pos. 2: P

Pos. 3: 80

Pos. 10: A, E, J

Pos. 11: _F21, FF11

Pos. 15: –

Ex code: 7.83.84.86.89.60

The following figure shows the relevant positions of the model code:

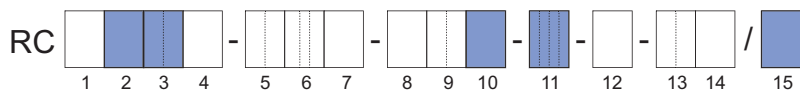

Tab. 26: Temperature classification

Temperature class	Maximum ambient temperature in °C (°F)		Maximum process fluid temperature in °C (°F)
	Option L _{....}	Option Y _{....}	
T6	42 (107)	42 (107)	64 (147)
T5	57 (134)	57 (134)	80 (176)
T4	80 (176)	66 (150)	117 (242)
T3	66 (150)	50 (122)	185 (365)
T2	60 (140)	46 (114)	200 (392)
T1	60 (140)	46 (114)	200 (392)

Model code:

Pos. 2: P

Pos. 3: 80

Pos. 10: A, E, J

Pos. 11: _F22, FF12

Pos. 15: –

Ex code: 6.83.84.86.89.60

The following figure shows the relevant positions of the model code:

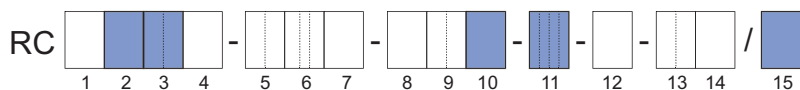

Tab. 27: Temperature classification

Temperature class	Maximum ambient temperature in °C (°F)		Maximum process fluid temperature in °C (°F)
	Option L _{....}	Option Y _{....}	
T6	46 (114)	46 (114)	64 (147)
T5	61 (141)	61 (141)	80 (176)
T4	80 (176)	66 (150)	117 (242)
T3	66 (150)	50 (122)	185 (365)
T2	60 (140)	46 (114)	200 (392)
T1	60 (140)	46 (114)	200 (392)

Model code:

Pos. 2: P

Pos. 3: 80

Pos. 10: A, E

Pos. 11: JF54, JF53

Ex code:

–

The following figure shows the relevant positions of the model code:

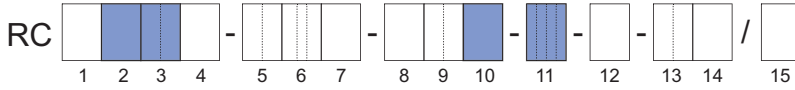

Tab. 28: Temperature classification

Temperature class	Maximum ambient temperature in °C		Maximum process fluid temperature in °C
	Option L ₋₋₋	Option Y ₋₋₋	
T4	80	–	117
T3	66	–	185

Model code:

Pos. 2: P

Pos. 3: 1H

Pos. 10: A, E, J

Pos. 11: _F21, _F22, FF11, FF12

Pos. 15: –

Ex code:

7.87.87.88.89.60

The following figure shows the relevant positions of the Model code:

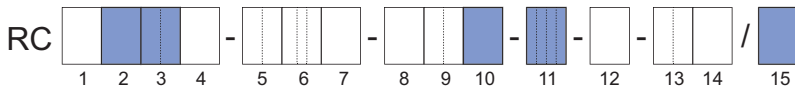

Tab. 29: Temperature classification

Temperature class	Maximum ambient temperature in °C (°F)		Maximum process fluid temperature in °C (°F)
	Option L ₋₋₋	Option Y ₋₋₋	
T6	40 (104)	40 (104)	68 (154)
T5	55 (131)	55 (131)	83 (181)
T4	80 (176)	66 (150)	119 (246)
T3	66 (150)	50 (122)	185 (365)
T2	60 (140)	46 (114)	200 (392)
T1	60 (140)	46 (114)	200 (392)

Model code:

Pos. 2: P

Pos. 3: 1H

Pos. 10: A, E

Pos. 11: JF54, JF53

Ex code:

-

The following figure shows the relevant positions of the Model code:

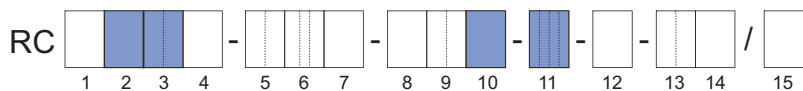

Tab. 30: Temperature classification

Temperature class	Maximum ambient temperature in °C		Maximum process fluid temperature in °C
	Option L _{xxx}	Option Y _{xxx}	
T4	80	–	119
T3	66	–	185

5 Mechanical specification

5.1 Design

The Rotamass Prime flow meter is available with two design types:

- Integral type, sensor and transmitter are firmly connected
- Remote type, standard neck

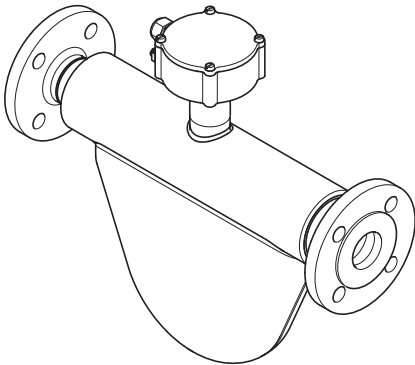
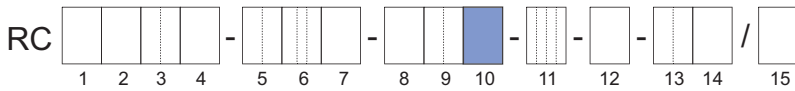

Fig. 15: Remote type sensor with standard neck



Design type	Design version	Process fluid temperature range	Model code position 10
Integral type	Direct connection	Standard	0, 2
Remote type	Standard neck		A, E, J



The design influences the temperature specification for Ex-approved Rotamass, see Explosion Proof Type Manual (IM 01U10X_--00_--R).

5.2 Material

5.2.1 Sensor

Material wetted parts

Sensor parts which are wetted by process fluid are available with the following materials:

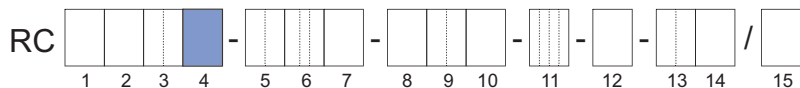

Material	Model code position 4
Stainless steel 1.4404/316L	S

The customer is responsible to ensure chemical compatibility of the material of the wetted parts with the measured process fluid.

Sensor housing material

Sensor housing is available in the following materials:

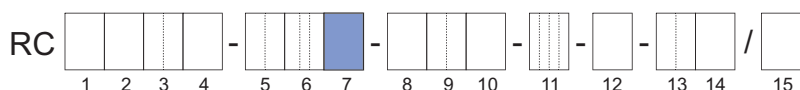

Housing part	Material	Model code position 7
Junction box	Stainless steel 1.4404/316L	–
Neck	Stainless steel 1.4308/304	–
Body	Stainless steel 1.4301/304	0

5.2.2 Transmitter

Transmitter housing

The transmitter housing is available with different materials and coatings:

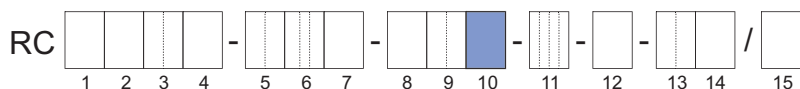

Housing material	Coating	Design type	Model code position 10
Aluminum Al-Si10Mg(Fe)	Standard coating	Integral type	0
		Remote type	A
	Corrosion protection coating	Integral type	2
		Remote type	E
Stainless steel CF8M	–	Remote type	J
	–		

- Standard coating: Urethane-cured polyester powder coating
- Corrosion protection coating: Three-layer coating with high chemical resistance (polyurethane coating on two layers of epoxy coating)
- Color Mint green (Munsell 5.6BG3.3/2.9)

Display window

This is relevant for all transmitters having a display:

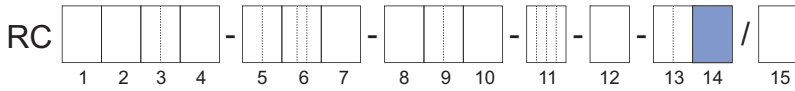

Display material	Model code position 14
Glass	1

Bracket material

The bracket is available for remote type devices only:

Bracket material	Design type	Model code position 10
Stainless steel 1.4404/316L	Remote type	A, B, E, F, J, K

5.2.3 Nameplates

Sensor

Sensor housing material	Process fluid temperature range	Option	Sensor nameplate material
1.4301/304	Standard	-	Polyester film
1.4301/304	Standard	/BN	1.4404/316L

Transmitter

Transmitter housing material	Transmitter nameplate material
Aluminum AL-Si10MG(Fe)	Foil
Stainless steel CF8M	1.4404/316L

5.3 Process connections, dimensions and weights of sensor

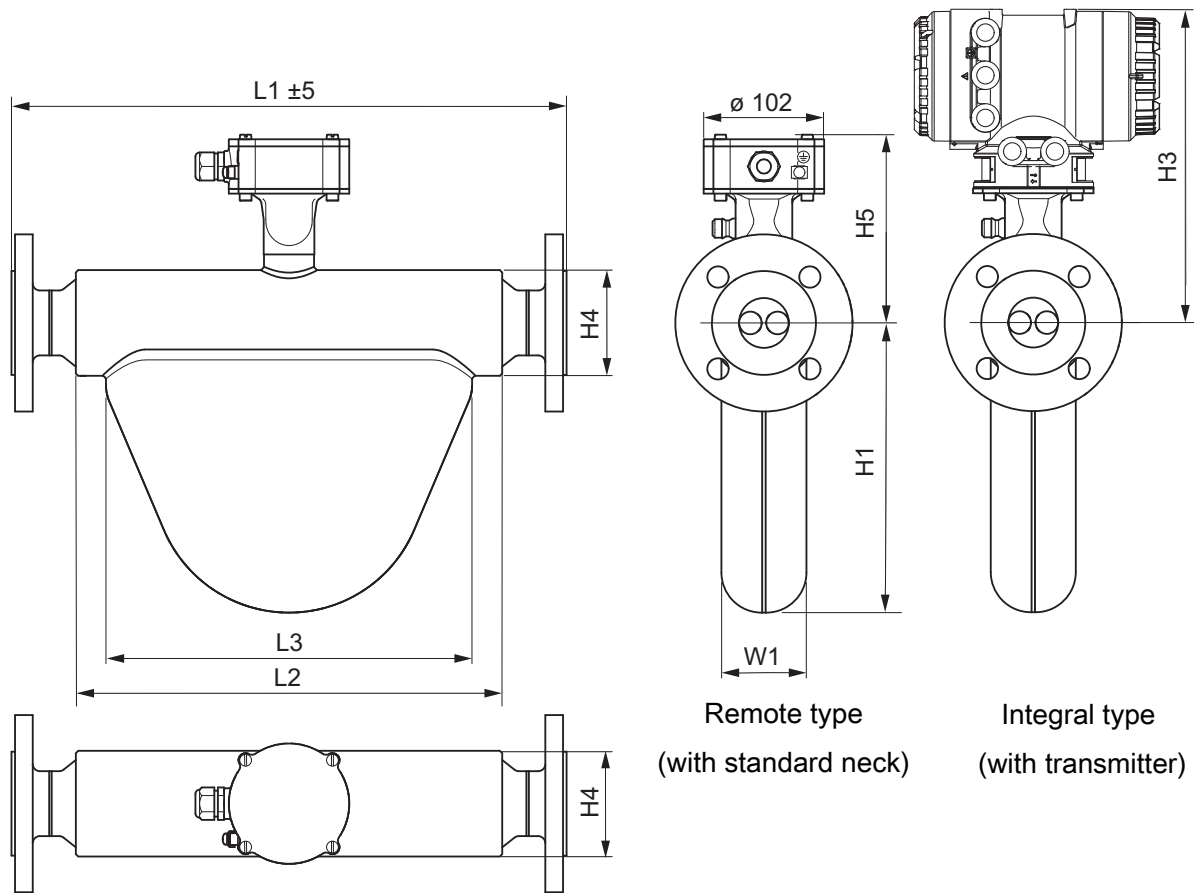

Fig. 16: Dimensions in mm

Tab. 31: Dimensions without length L1

Meter size	L2	L3	H1	H3	H4	H5	W1
	in mm (inch)						
Prime 25	190 (7.5)	165 (6.5)	117 (4.6)	268 (10.6)	56 (2.2)	138 (5.4)	42 (1.7)
Prime 40	227 (8.9)	195 (7.7)	145 (5.7)	277 (10.9)	71 (2.8)	148 (5.8)	50 (2)
Prime 50	361 (14.2)	310 (12.2)	245 (9.6)	289 (11.4)	90 (3.5)	159 (6.3)	72 (2.8)
Prime 80	455 (17.9)	400 (15.7)	333 (13.1)	296 (11.7)	102 (4)	167 (6.6)	96 (3.8)
Prime 1H	682 (26.9)	620 (24.4)	482 (19)	330 (13)	168 (6.6)	201 (7.9)	150 (5.9)

Overall length L1 and weight

The overall length of the sensor depends on the selected process connection (type and size). The following tables list the overall length and weight (without customized installation length options) as functions of the individual process connection.

The weights in the tables are for the remote type. Additional weight for the integral type: up to 3.2 kg (7.1 lb).

Mechanical specification

Process connections compatible to ASME B16.5 (AISI 316/ AISI 316L dual certified)

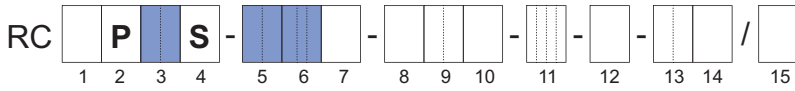

Tab. 32: Overall length L1 and weight of sensor (process connections: ASME)

Process connections	Model code pos.		Prime 25		Prime 40		Prime 50		Prime 80		Prime 1H	
	5	6	L1 in mm (inch)	Weight in kg (lb)	L1 in mm (inch)	Weight in kg (lb)	L1 in mm (inch)	Weight in kg (lb)	L1 in mm (inch)	Weight in kg (lb)	L1 in mm (inch)	Weight in kg (lb)
ASME ½" class 150, raised face (RF)	15	BA1	280 (11)	6 (13)	320 (12.6)	8 (18)	-	-	-	-	-	-
ASME ½" class 300, raised face (RF)		BA2	280 (11)	6.4 (14)	320 (12.6)	8.4 (18)	-	-	-	-	-	-
ASME ½" class 600, raised face (RF)		BA4	290 (11.4)	6.7 (15)	330 (13)	8.7 (19)	-	-	-	-	-	-
ASME ½" class 600, ring joint (RJ)		CA4	290 (11.4)	6.6 (15)	330 (13)	8.6 (19)	-	-	-	-	-	-
ASME 1" class 150, raised face (RF)	25	BA1	280 (11)	6.9 (15)	320 (12.6)	8.9 (20)	490 (19.3)	15.7 (35)	-	-	-	-
ASME 1" class 300, raised face (RF)		BA2	280 (11)	7.9 (17)	320 (12.6)	9.9 (22)	490 (19.3)	16.7 (37)	-	-	-	-
ASME 1" class 600, raised face (RF)		BA4	300 (11.8)	8.3 (18)	340 (13.4)	10.3 (23)	500 (19.7)	17 (38)	-	-	-	-
ASME 1" class 600, ring joint (RJ)		CA4	300 (11.8)	8.4 (19)	340 (13.4)	10.4 (23)	500 (19.7)	17.2 (38)	-	-	-	-
ASME 1½" class 150, raised face (RF)	40	BA1	290 (11.4)	7.8 (17)	330 (13)	9.8 (22)	470 (18.5)	16.5 (36)	620 (24.4)	25.7 (57)	-	-
ASME 1½" class 300, raised face (RF)		BA2	290 (11.4)	10.1 (22)	330 (13)	12.1 (27)	480 (18.9)	19 (42)	620 (24.4)	28.1 (62)	-	-
ASME 1½" class 600, raised face (RF)		BA4	310 (12.2)	11.5 (25)	350 (13.8)	13.5 (30)	500 (19.7)	20 (44)	630 (24.8)	28.9 (64)	-	-
ASME 1½" class 600, ring joint (RJ)		CA4	310 (12.2)	11.4 (25)	350 (13.8)	13.4 (30)	500 (19.7)	20 (44)	630 (24.8)	29.1 (64)	-	-
ASME 2" class 150, raised face (RF)	50	BA1	-	-	-	-	480 (18.9)	18.1 (40)	580 (22.8)	26.8 (59)	-	-
ASME 2" class 300, raised face (RF)		BA2	-	-	-	-	480 (18.9)	19.7 (43)	580 (22.8)	28.3 (62)	-	-
ASME 2" class 600, raised face (RF)		BA4	-	-	-	-	510 (20.1)	21.3 (47)	610 (24)	30.5 (67)	-	-
ASME 2" class 600, ring joint (RJ)		CA4	-	-	-	-	510 (20.1)	21.8 (48)	610 (24)	30.3 (67)	-	-

Process connections	Model code pos.		Prime 25		Prime 40		Prime 50		Prime 80		Prime 1H	
	5	6	L1 in mm (inch)	Weight in kg (lb)	L1 in mm (inch)	Weight in kg (lb)	L1 in mm (inch)	Weight in kg (lb)	L1 in mm (inch)	Weight in kg (lb)	L1 in mm (inch)	Weight in kg (lb)
	ASME 2½" class 150, raised face (RF)	65	BA1	–	–	–	–	–	–	580 (22.8)	29.8 (66)	–
ASME 2½" class 300, raised face (RF)	BA2		–	–	–	–	–	–	580 (22.8)	31.3 (69)	–	–
ASME 2½" class 600, raised face (RF)	BA4		–	–	–	–	–	–	610 (24)	33.4 (74)	–	–
ASME 2½" class 600, ring joint (RJ)	CA4		–	–	–	–	–	–	610 (24)	33.8 (74)	–	–
ASME 3" class 150, raised face (RF)	80	BA1	–	–	–	–	–	–	580 (22.8)	30.9 (68)	870 (34.3)	71.2 (157)
ASME 3" class 300, raised face (RF)		BA2	–	–	–	–	–	–	590 (23.2)	34.5 (76)	880 (34.6)	75 (165)
ASME 3" class 600, raised face (RF)		BA4	–	–	–	–	–	–	630 (24.8)	37.8 (83)	900 (35.4)	77.7 (171)
ASME 3" class 600, ring joint (RJ)		CA4	–	–	–	–	–	–	610 (24)	38.4 (85)	900 (35.4)	78.3 (173)
ASME 4" class 150, raised face (RF)	1H	BA1	–	–	–	–	–	–	–	–	850 (33.5)	74.4 (164)
ASME 4" class 300, raised face (RF)		BA2	–	–	–	–	–	–	–	–	850 (33.5)	81.8 (180)
ASME 4" class 600, raised face (RF)		BA4	–	–	–	–	–	–	–	–	920 (36.2)	94 (207)
ASME 4" class 600, ring joint (RJ)		CA4	–	–	–	–	–	–	–	–	920 (36.2)	94.6 (209)
ASME 5" class 150, raised face (RF)	1Q	BA1	–	–	–	–	–	–	–	–	870 (34.3)	77 (170)
ASME 5" class 300, raised face (RF)		BA2	–	–	–	–	–	–	–	–	890 (35)	89.4 (197)
ASME 5" class 600, raised face (RF)		BA4	–	–	–	–	–	–	–	–	920 (36.2)	114.2 (252)
ASME 5" class 600, ring joint (RJ)		CA4	–	–	–	–	–	–	–	–	920 (36.2)	114.9 (253)

Meaning of "–": not available

Mechanical specification

Process connections compatible to EN 1092-1 (1.4404/ AISI 316 L)

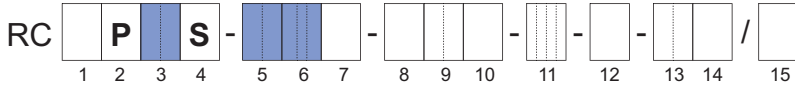

Tab. 33: Overall length L1 and weight of sensor (process connections: EN)

Process connections	Model code pos.		Prime 25		Prime 40		Prime 50		Prime 80		Prime 1H	
	5	6	L1 in mm (inch)	Weight in kg (lb)	L1 in mm (inch)	Weight in kg (lb)	L1 in mm (inch)	Weight in kg (lb)	L1 in mm (inch)	Weight in kg (lb)	L1 in mm (inch)	Weight in kg (lb)
EN DN15 PN40, type B1, raised face (RF)	15	BD4	280 (11)	6.6 (14)	320 (12.6)	8.6 (19)	-	-	-	-	-	-
EN DN15 PN40, type D, with groove		GD4	280 (11)	6.4 (14)	320 (12.6)	8.4 (18)	-	-	-	-	-	-
EN DN15 PN40, type E, with spigot		ED4	280 (11)	6.3 (14)	320 (12.6)	8.3 (18)	-	-	-	-	-	-
EN DN15 PN40, type F, with recess		FD4	280 (11)	6.5 (14)	320 (12.6)	8.5 (19)	-	-	-	-	-	-
EN DN15 PN100, type B1, raised face (RF)		BD6	290 (11.4)	7.4 (16)	330 (13)	9.4 (21)	-	-	-	-	-	-
EN DN15 PN100, type D, with groove		GD6	290 (11.4)	7.4 (16)	330 (13)	9.4 (21)	-	-	-	-	-	-
EN DN15 PN100, type E, with spigot		ED6	290 (11.4)	7.1 (16)	330 (13)	9.1 (20)	-	-	-	-	-	-
EN DN15 PN100, type F, with recess		FD6	290 (11.4)	7.3 (16)	330 (13)	9.3 (21)	-	-	-	-	-	-
EN DN25 PN40, type B1, raised face (RF)	25	BD4	280 (11)	7.5 (17)	320 (12.6)	9.5 (21)	490 (19.3)	16.4 (36)	-	-	-	-
EN DN25 PN40, type D, with groove		GD4	280 (11)	7.5 (16)	320 (12.6)	9.5 (21)	490 (19.3)	16.3 (36)	-	-	-	-
EN DN25 PN40, type E, with spigot		ED4	280 (11)	7.2 (16)	320 (12.6)	9.2 (20)	490 (19.3)	16.1 (35)	-	-	-	-
EN DN25 PN40, type F, with recess		FD4	280 (11)	7.4 (16)	320 (12.6)	9.4 (21)	490 (19.3)	16.3 (36)	-	-	-	-
EN DN25 PN100, type B1, raised face (RF)		BD6	300 (11.8)	10.1 (22)	340 (13.4)	12.1 (27)	490 (19.3)	18.8 (41)	-	-	-	-
EN DN25 PN100, type D, with groove		GD6	300 (11.8)	10 (22)	340 (13.4)	12 (26)	490 (19.3)	18.7 (41)	-	-	-	-
EN DN25 PN100, type E, with spigot		ED6	300 (11.8)	9.5 (21)	340 (13.4)	11.5 (25)	490 (19.3)	18.3 (40)	-	-	-	-
EN DN25 PN100, type F, with recess		FD6	300 (11.8)	9.9 (22)	340 (13.4)	11.9 (26)	490 (19.3)	18.7 (41)	-	-	-	-

Process connections	Model code pos.		Prime 25		Prime 40		Prime 50		Prime 80		Prime 1H	
	5	6	L1 in mm (inch)	Weight in kg (lb)	L1 in mm (inch)	Weight in kg (lb)	L1 in mm (inch)	Weight in kg (lb)	L1 in mm (inch)	Weight in kg (lb)	L1 in mm (inch)	Weight in kg (lb)
	EN DN40 PN40, type B1, raised face (RF)	40	BD4	280 (11)	9.1 (20)	320 (12.6)	11.1 (24)	470 (18.5)	17.7 (39)	610 (24)	26.9 (59)	–
EN DN40 PN40, type D, with groove	GD4		280 (11)	8.9 (20)	320 (12.6)	10.9 (24)	470 (18.5)	17.6 (39)	610 (24)	26.8 (59)	–	–
EN DN40 PN40, type E, with spigot	ED4		280 (11)	8.6 (19)	320 (12.6)	10.6 (23)	470 (18.5)	17.4 (38)	610 (24)	26.5 (58)	–	–
EN DN40 PN40, type F, with recess	FD4		280 (11)	8.8 (19)	320 (12.6)	10.8 (24)	470 (18.5)	17.5 (39)	610 (24)	26.7 (59)	–	–
EN DN40 PN100, type B1, raised face (RF)	BD6		360 (14.2)	13.5 (30)	400 (15.7)	15.5 (34)	500 (19.7)	21.5 (47)	610 (24)	30.5 (67)	–	–
EN DN40 PN100, type D, with groove	GD6		360 (14.2)	13.4 (30)	400 (15.7)	15.4 (34)	500 (19.7)	21.4 (47)	610 (24)	30.4 (67)	–	–
EN DN40 PN100, type E, with spigot	ED6		360 (14.2)	13 (29)	400 (15.7)	15 (33)	500 (19.7)	21.1 (46)	610 (24)	30 (66)	–	–
EN DN40 PN100, type F, with recess	FD6		360 (14.2)	13.3 (29)	400 (15.7)	15.3 (34)	500 (19.7)	21.3 (47)	610 (24)	30.3 (67)	–	–
EN DN50 PN40, type B1, raised face (RF)	50	BD4	–	–	–	–	470 (18.5)	19.1 (42)	580 (22.8)	27.8 (61)	–	–
EN DN50 PN40, type D, with groove		GD4	–	–	–	–	470 (18.5)	18.9 (42)	580 (22.8)	27.7 (61)	–	–
EN DN50 PN40, type E, with spigot		ED4	–	–	–	–	470 (18.5)	18.6 (41)	580 (22.8)	27.4 (60)	–	–
EN DN50 PN40, type F, with recess		FD4	–	–	–	–	470 (18.5)	18.8 (41)	580 (22.8)	27.6 (61)	–	–
EN DN50 PN100, type B1, raised face (RF)		BD6	–	–	–	–	540 (21.3)	25.4 (56)	610 (24)	33.5 (74)	–	–
EN DN50 PN100, type D, with groove		GD6	–	–	–	–	540 (21.3)	25.3 (56)	610 (24)	33.4 (74)	–	–
EN DN50 PN100, type E, with spigot		ED6	–	–	–	–	540 (21.3)	24.8 (55)	610 (24)	32.9 (72)	–	–
EN DN50 PN100, type F, with recess		FD6	–	–	–	–	540 (21.3)	25.2 (55)	610 (24)	33.2 (73)	–	–

Mechanical specification

Process connections	Model code pos.		Prime 25		Prime 40		Prime 50		Prime 80		Prime 1H	
	5	6	L1 in mm (inch)	Weight in kg (lb)	L1 in mm (inch)	Weight in kg (lb)	L1 in mm (inch)	Weight in kg (lb)	L1 in mm (inch)	Weight in kg (lb)	L1 in mm (inch)	Weight in kg (lb)
EN DN80 PN40, type B1, raised face (RF)	80	BD4	–	–	–	–	–	–	590 (23.2)	31.5 (69)	870 (34.3)	71.6 (158)
EN DN80 PN40, type D, with groove		GD4	–	–	–	–	–	–	590 (23.2)	31.3 (69)	870 (34.3)	71.1 (157)
EN DN80 PN40, type E, with spigot		ED4	–	–	–	–	–	–	590 (23.2)	30.9 (68)	870 (34.3)	70.7 (156)
EN DN80 PN40, type F, with recess		FD4	–	–	–	–	–	–	590 (23.2)	31.1 (69)	870 (34.3)	70.9 (156)
EN DN80 PN100, type B1, raised face (RF)		BD6	–	–	–	–	–	–	650 (25.6)	40 (88)	890 (35)	79.1 (174)
EN DN80 PN100, type D, with groove		GD6	–	–	–	–	–	–	650 (25.6)	39.8 (88)	890 (35)	78.9 (174)
EN DN80 PN100, type E, with spigot		ED6	–	–	–	–	–	–	650 (25.6)	39.2 (86)	890 (35)	78.3 (173)
EN DN80 PN100, type F, with recess		FD6	–	–	–	–	–	–	650 (25.6)	39.6 (87)	890 (35)	78.7 (173)
EN DN100 PN40, type B1, raised face (RF)	1H	BD4	–	–	–	–	–	–	–	–	850 (33.5)	73.8 (163)
EN DN100 PN40, type D, with groove		GD4	–	–	–	–	–	–	–	–	850 (33.5)	73.6 (162)
EN DN100 PN40, type E, with spigot		ED4	–	–	–	–	–	–	–	–	850 (33.5)	73 (161)
EN DN100 PN40, type F, with recess		FD4	–	–	–	–	–	–	–	–	850 (33.5)	73.3 (162)
EN DN100 PN100, type B1, raised face (RF)		BD6	–	–	–	–	–	–	–	–	870 (34.3)	85.2 (188)
EN DN100 PN100, type D, with groove		GD6	–	–	–	–	–	–	–	–	870 (34.3)	84.8 (187)
EN DN100 PN100, type E, with spigot		ED6	–	–	–	–	–	–	–	–	870 (34.3)	84 (185)
EN DN100 PN100, type F, with recess		FD6	–	–	–	–	–	–	–	–	870 (34.3)	84.5 (186)

Process connections	Model code pos.		Prime 25		Prime 40		Prime 50		Prime 80		Prime 1H	
	5	6	L1 in mm (inch)	Weight in kg (lb)	L1 in mm (inch)	Weight in kg (lb)	L1 in mm (inch)	Weight in kg (lb)	L1 in mm (inch)	Weight in kg (lb)	L1 in mm (inch)	Weight in kg (lb)
	EN DN125 PN40, type B1, raised face (RF)	1Q	BD4	–	–	–	–	–	–	–	–	860 (33.9)
EN DN125 PN40, type D, with groove	GD4		–	–	–	–	–	–	–	–	860 (33.9)	78.1 (172)
EN DN125 PN40, type E, with spigot	ED4		–	–	–	–	–	–	–	–	860 (33.9)	77.4 (171)
EN DN125 PN40, type F, with recess	FD4		–	–	–	–	–	–	–	–	860 (33.9)	77.7 (171)
EN DN125 PN100, type B1, raised face (RF)	BD6		–	–	–	–	–	–	–	–	880 (34.6)	98 (216)
EN DN125 PN100, type D, with groove	GD6		–	–	–	–	–	–	–	–	880 (34.6)	97.6 (215)
EN DN125 PN100, type E, with spigot	ED6		–	–	–	–	–	–	–	–	880 (34.6)	96.3 (212)
EN DN125 PN100, type F, with recess	FD6		–	–	–	–	–	–	–	–	880 (34.6)	97.1 (214)

Meaning of "–": not available

Process connections compatible to JIS B 2220 (AISI 316/ AISI 316 L)

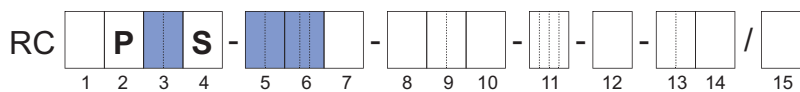

Tab. 34: Overall length L1 and weight of sensor (process connections: JIS)

Process connections	Model code pos.		Prime 25		Prime 40		Prime 50		Prime 80		Prime 1H	
	5	6	L1 in mm (inch)	Weight in kg (lb)	L1 in mm (inch)	Weight in kg (lb)	L1 in mm (inch)	Weight in kg (lb)	L1 in mm (inch)	Weight in kg (lb)	L1 in mm (inch)	Weight in kg (lb)
	JIS DN15 10K	15	BJ1	280 (11)	6.3 (14)	320 (12.6)	8.3 (18)	–	–	–	–	–
JIS DN15 20K	BJ2		280 (11)	6.5 (14)	320 (12.6)	8.5 (19)	–	–	–	–	–	–
JIS DN25 10K	25	BJ1	280 (11)	7.4 (16)	320 (12.6)	9.4 (21)	490 (19.3)	16.3 (36)	–	–	–	–
JIS DN25 20K		BJ2	280 (11)	7.8 (17)	320 (12.6)	9.8 (22)	490 (19.3)	16.6 (37)	–	–	–	–
JIS DN40 10K	40	BJ1	280 (11)	8.2 (18)	320 (12.6)	10.2 (23)	470 (18.5)	16.9 (37)	620 (24.4)	26.1 (58)	–	–
JIS DN40 20K		BJ2	280 (11)	8.6 (19)	320 (12.6)	10.6 (23)	470 (18.5)	17.3 (38)	620 (24.4)	26.5 (58)	–	–
JIS DN50 10K	50	BJ1	–	–	–	–	470 (18.5)	17.5 (39)	600 (23.6)	26.6 (59)	–	–
JIS DN50 20K		BJ2	–	–	–	–	470 (18.5)	17.7 (39)	600 (23.6)	26.7 (59)	–	–

Mechanical specification

Process connections	Model code pos.		Prime 25		Prime 40		Prime 50		Prime 80		Prime 1H	
	5	6	L1 in mm (inch)	Weight in kg (lb)	L1 in mm (inch)	Weight in kg (lb)	L1 in mm (inch)	Weight in kg (lb)	L1 in mm (inch)	Weight in kg (lb)	L1 in mm (inch)	Weight in kg (lb)
JIS DN80 10K	80	BJ1	–	–	–	–	–	–	570 (22.4)	27.9 (62)	880 (34.6)	68.7 (151)
JIS DN80 20K		BJ2	–	–	–	–	–	–	580 (22.8)	30.4 (67)	880 (34.6)	71 (156)
JIS DN100 10K	1H	BJ1	–	–	–	–	–	–	–	–	850 (33.5)	69.8 (154)
JIS DN100 20K		BJ2	–	–	–	–	–	–	–	–	850 (33.5)	73.4 (162)
JIS DN125 10K	1Q	BJ1	–	–	–	–	–	–	–	–	850 (33.5)	73.5 (162)
JIS DN125 20K		BJ2	–	–	–	–	–	–	–	–	850 (33.5)	79.7 (176)

Meaning of "–": not available

Process connections compatible to JPI

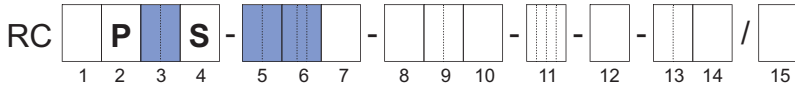

Tab. 35: Overall length L1 and weight of sensor (process connections: JPI)

Process connections	Model code pos.		Prime 25		Prime 40		Prime 50		Prime 80		Prime 1H	
	5	6	L1 in mm (inch)	Weight in kg (lb)	L1 in mm (inch)	Weight in kg (lb)	L1 in mm (inch)	Weight in kg (lb)	L1 in mm (inch)	Weight in kg (lb)	L1 in mm (inch)	Weight in kg (lb)
JPI ½" class 150	15	BP1	280 (11)	5.9 (13)	320 (12.6)	7.9 (18)	–	–	–	–	–	–
JPI ½" class 300		BP2	280 (11)	6.4 (14)	320 (12.6)	8.4 (18)	–	–	–	–	–	–
JPI ½" class 600		BP4	290 (11.4)	6.6 (14)	330 (13)	8.6 (19)	–	–	–	–	–	–
JPI 1" class 150	25	BP1	280 (11)	6.7 (15)	320 (12.6)	8.7 (19)	490 (19.3)	15.7 (35)	–	–	–	–
JPI 1" class 300		BP2	280 (11)	7.8 (17)	320 (12.6)	9.8 (22)	490 (19.3)	16.7 (37)	–	–	–	–
JPI 1" class 600		BP4	300 (11.8)	8.2 (18)	340 (13.4)	10.2 (22)	500 (19.7)	17 (38)	–	–	–	–
JPI 1½" class 150	40	BP1	290 (11.4)	7.9 (17)	330 (13)	9.9 (22)	470 (18.5)	16.5 (36)	620 (24.4)	25.7 (57)	–	–
JPI 1½" class 300		BP2	290 (11.4)	10.1 (22)	330 (13)	12.1 (27)	480 (18.9)	18.9 (42)	620 (24.4)	28 (62)	–	–
JPI 1½" class 600		BP4	310 (12.2)	11.2 (25)	350 (13.8)	13.2 (29)	500 (19.7)	19.9 (44)	630 (24.8)	28.9 (64)	–	–
JPI 2" class 150	50	BP1	–	–	–	–	480 (18.9)	18.1 (40)	580 (22.8)	26.8 (59)	–	–
JPI 2" class 300		BP2	–	–	–	–	480 (18.9)	19.7 (43)	580 (22.8)	28.3 (62)	–	–
JPI 2" class 600		BP4	–	–	–	–	510 (20.1)	21.4 (47)	610 (24)	30.1 (66)	–	–

Process connections	Model code pos.		Prime 25		Prime 40		Prime 50		Prime 80		Prime 1H	
	5	6	L1 in mm (inch)	Weight in kg (lb)	L1 in mm (inch)	Weight in kg (lb)	L1 in mm (inch)	Weight in kg (lb)	L1 in mm (inch)	Weight in kg (lb)	L1 in mm (inch)	Weight in kg (lb)
JPI 2½" class 150	65	BP1	–	–	–	–	–	–	580 (22.8)	29.5 (65)	–	–
JPI 2½" class 300		BP2	–	–	–	–	–	–	580 (22.8)	31.1 (68)	–	–
JPI 2½" class 600		BP4	–	–	–	–	–	–	610 (24)	33.2 (73)	–	–
JPI 3" class 150	80	BP1	–	–	–	–	–	–	580 (22.8)	30.9 (68)	870 (34.3)	71.2 (157)
JPI 3" class 300		BP2	–	–	–	–	–	–	590 (23.2)	34.5 (76)	880 (34.6)	75.1 (166)
JPI 3" class 600		BP4	–	–	–	–	–	–	610 (24)	37.3 (82)	900 (35.4)	77.8 (171)
JPI 4" class 150	1H	BP1	–	–	–	–	–	–	–	–	850 (33.5)	74.5 (164)
JPI 4" class 300		BP2	–	–	–	–	–	–	–	–	850 (33.5)	81.9 (181)
JPI 4" class 600		BP4	–	–	–	–	–	–	–	–	920 (36.2)	93.9 (207)
JPI 5" class 150	1Q	BP1	–	–	–	–	–	–	–	–	870 (34.3)	77.1 (170)
JPI 5" class 300		BP2	–	–	–	–	–	–	–	–	890 (35)	89.6 (198)

Meaning of "–": not available

Process connections with internal thread G

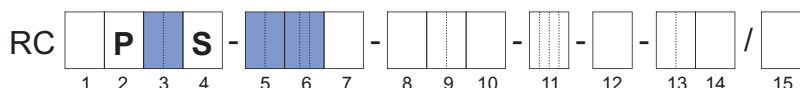

Tab. 36: Overall length L1 and weight of sensor (process connections: G thread)

Process connections	Model code pos.		Prime 25		Prime 40		Prime 50		Prime 80		Prime 1H	
	5	6	L1 in mm (inch)	Weight in kg (lb)	L1 in mm (inch)	Weight in kg (lb)	L1 in mm (inch)	Weight in kg (lb)	L1 in mm (inch)	Weight in kg (lb)	L1 in mm (inch)	Weight in kg (lb)
G ⅜"	08	TG9	300 (11.8)	5.4 (12)	–	–	–	–	–	–	–	–
G ½"	15		300 (11.8)	5.4 (12)	340 (13.4)	7.4 (16)	–	–	–	–	–	–
G ¾"	20		300 (11.8)	5.3 (12)	340 (13.4)	7.3 (16)	–	–	–	–	–	–

Meaning of "–": not available

Mechanical specification

Process connections with internal thread NPT

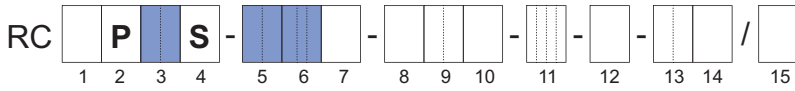

Tab. 37: Overall length L1 and weight of sensor (process connections: NPT thread)

Process connections	Model code pos.		Prime 25		Prime 40		Prime 50		Prime 80		Prime 1H	
	5	6	L1 in mm (inch)	Weight in kg (lb)	L1 in mm (inch)	Weight in kg (lb)	L1 in mm (inch)	Weight in kg (lb)	L1 in mm (inch)	Weight in kg (lb)	L1 in mm (inch)	Weight in kg (lb)
NPT 3/8"	08	TT9	300 (11.8)	5.4 (12)	-	-	-	-	-	-	-	-
NPT 1/2"	15		300 (11.8)	5.4 (12)	340 (13.4)	7.4 (16)	-	-	-	-	-	-
NPT 3/4"	20		300 (11.8)	5.3 (12)	340 (13.4)	7.3 (16)	-	-	-	-	-	-

Meaning of "-": not available

NAMUR & Customer length

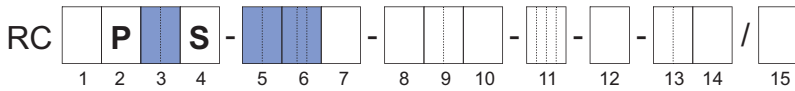

Overall length and weight for customized installation length

Tab. 38: Available process connections for options NL and CL with minimum and maximum installation length

Model code pos.		Prime 25		Prime 40		Prime 50		Prime 80		Prime 1H	
5	6	CL min in mm (inch)	CL max (NL) in mm (inch)	CL min in mm (inch)	CL max (NL) in mm (inch)	CL min in mm (inch)	CL max (NL) in mm (inch)	CL min in mm (inch)	CL max (NL) in mm (inch)	CL min in mm (inch)	CL max (NL) in mm (inch)
15	BA1, BA2, BD4, BJ1, BJ2, BP1, BP2, ED4, FD4, GD4	340 (13.4)	510 (20.1)	380 (15)	510 (20.1)	-	-	-	-	-	-
	CA4, BA4, BP4	350 (13.8)	510 (20.1)	390 (15.4)	510 (20.1)	-	-	-	-	-	-
25	BA1, BA2, BD4, BJ1, BJ2, BP1, BP2, ED4, FD4, GD4	340 (13.4)	600 (23.6)	380 (15)	600 (23.6)	550 (21.7)	600 (23.6)	-	-	-	-
	CA4, BA4, BP4	360 (14.2)	600 (23.6)	400 (15.7)	600 (23.6)	560 (22)	600 (23.6)	-	-	-	-
40	BJ1, BJ2, BD4, ED4, FD4, GD4	340 (13.4)	600 (23.6)	380 (15)	600 (23.6)	530 (20.9)	600 (23.6)	-	-	-	-
	BP1, BA1	350 (13.8)	600 (23.6)	390 (15.4)	600 (23.6)	530 (20.9)	600 (23.6)	-	-	-	-
	BA2, BP2	350 (13.8)	600 (23.6)	390 (15.4)	600 (23.6)	540 (21.3)	600 (23.6)	-	-	-	-
	BP4, CA4, BA4	370 (14.6)	600 (23.6)	410 (16.1)	600 (23.6)	560 (22)	600 (23.6)	-	-	-	-

Model code pos.		Prime 25		Prime 40		Prime 50		Prime 80		Prime 1H	
5	6	CL min	CL max	CL min	CL max	CL min	CL max	CL min	CL max	CL min	CL max
		in mm (inch)	(NL) in mm (inch)	in mm (inch)	(NL) in mm (inch)	in mm (inch)	(NL) in mm (inch)	in mm (inch)	(NL) in mm (inch)	in mm (inch)	(NL) in mm (inch)
50	BJ1, BJ2, BD4, ED4, FD4, GD4	–	–	–	–	530 (20.9)	715 (28.1)	660 (26)	715 (28.1)	–	–
	BA1, BP1, BA2, BP2	–	–	–	–	540 (21.3)	715 (28.1)	640 (25.2)	715 (28.1)	–	–
	BA4, BP4, CA4	–	–	–	–	570 (22.4)	715 (28.1)	670 (26.4)	715 (28.1)	–	–
65	BA1, BP1, BA2, BP2	–	–	–	–	–	–	640 (25.2)	715 (28.1)	–	–
	BA4, BP4, CA4	–	–	–	–	–	–	670 (26.4)	715 (28.1)	–	–
80	BJ1	–	–	–	–	–	–	630 (24.8)	915 (36)	–	–
	BA1, BP1, BJ2	–	–	–	–	–	–	640 (25.2)	915 (36)	–	–
	BA2, BD4, BP2, ED4, FD4, GD4	–	–	–	–	–	–	650 (25.6)	915 (36)	–	–
	BP4, CA4	–	–	–	–	–	–	670 (26.4)	915 (36)	–	–
	BA4	–	–	–	–	–	–	690 (27.2)	915 (36)	–	–
1H	BA1, BA2, BD4, BJ1, BJ2, BP1, BP2, ED4, FD4, GD4	–	–	–	–	–	–	–	–	910 (35.8)	1400 (55.1)
	BA4, BP4, CA4	–	–	–	–	–	–	–	–	980 (38.6)	1400 (55.1)
1Q	BJ1, BJ2	–	–	–	–	–	–	–	–	910 (35.8)	1400 (55.1)
	BD4, ED4, FD4, GD4	–	–	–	–	–	–	–	–	920 (36.2)	1400 (55.1)
	BA1, BP1	–	–	–	–	–	–	–	–	930 (36.6)	1400 (55.1)
	BA2, BP2	–	–	–	–	–	–	–	–	950 (37.4)	1400 (55.1)

Meaning of "–": not available, "CL": Customer length, "NL": NAMUR length; NL corresponds to CL max

Mechanical specification

Tab. 39: Additional weight in combination with options NL and CL

	Prime 25	Prime 40	Prime 50	Prime 80	Prime 1H
Additional weight for customized installation length in kg/mm	0.003	0.003	0.005	0.009	0.018

Typical dimensions of measuring tubes

Tab. 40: Typical dimensions of measuring tubes

Meter size	Material of wetted parts	Model code pos. 4	Internal diameter in mm (inch)	Wall thickness in mm (inch)
Prime25	Stainless steel 1.4404/316L	S	5.60 (0.220)	0.45 (0.018)
Prime40			9.00 (0.354)	0.50 (0.020)
Prime50			17.10 (0.673)	0.95 (0.037)
Prime80			27.60 (1.087)	1.70 (0.067)
Prime1H			45.80 (1.803)	2.60 (0.102)

5.4 Transmitter dimensions and weights

Transmitter dimensions

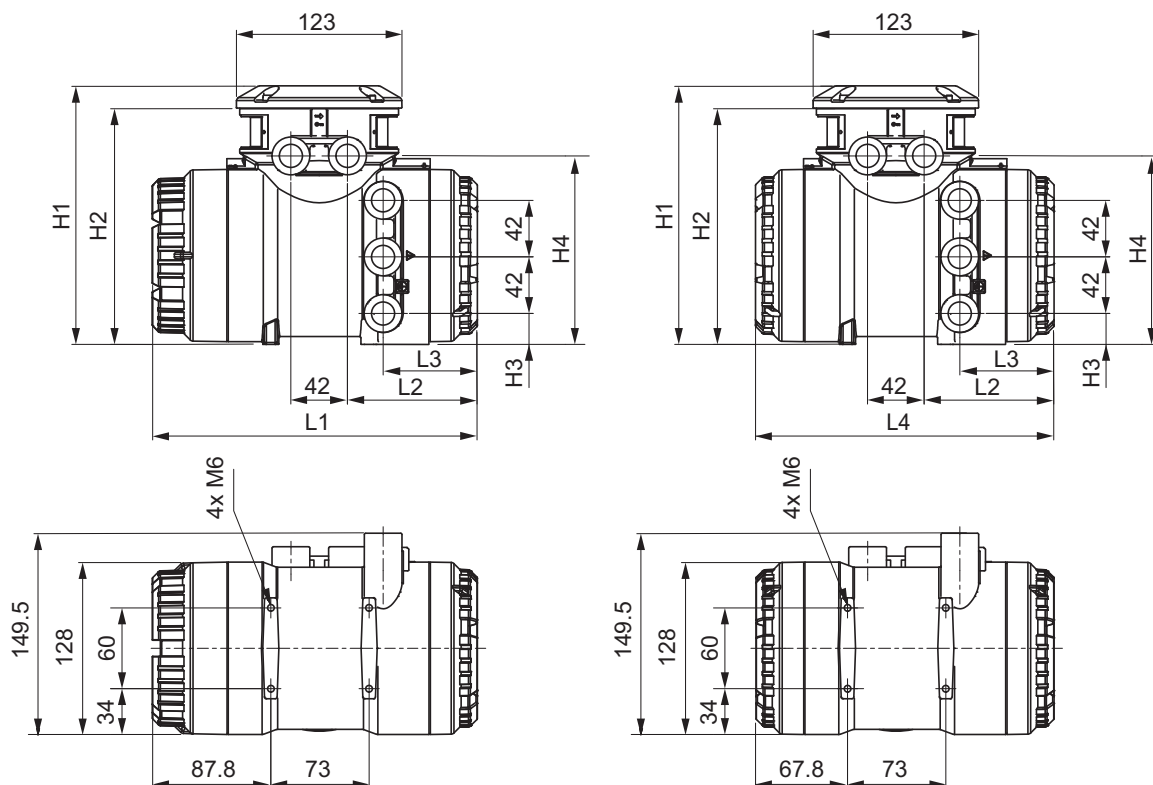

Fig. 17: Dimensions of transmitter in mm (left: transmitter with display, right: transmitter without display)

Tab. 41: Overall length L1 - L4 and height H1 - H4 of transmitter (material: stainless steel, aluminum)

Material	L1 in mm (inch)	L2 in mm (inch)	L3 in mm (inch)	L4 in mm (inch)	H1 in mm (inch)	H2 in mm (inch)	H3 in mm (inch)	H4 in mm (inch)
Stainless steel	255.5 (10.06)	110.5 (4.35)	69 (2.72)	235 (9.25)	201 (7.91)	184 (7.24)	24 (0.94)	150.5 (5.93)
Aluminum	241.5 (9.51)	96.5 (3.8)	70 (2.76)	221 (8.7)	192 (7.56)	175 (6.89)	23 (0.91)	140 (5.51)

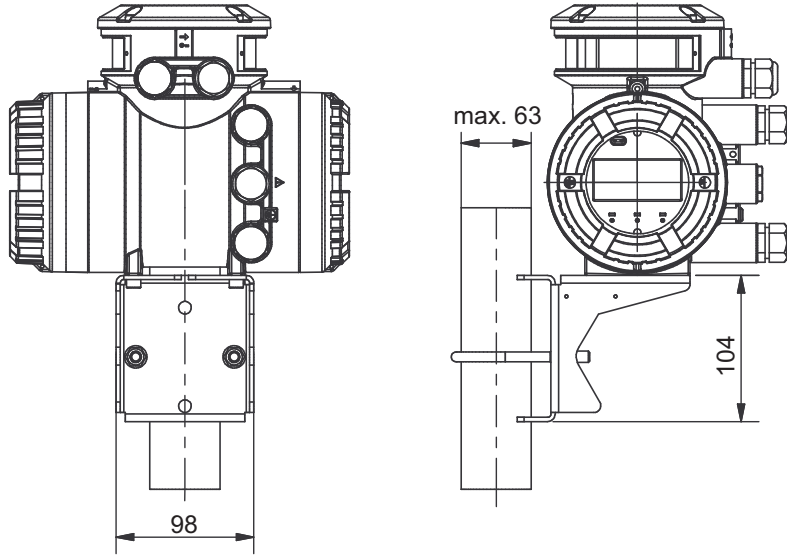
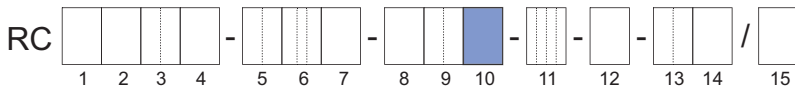

Fig. 18: Dimensions of transmitter in mm, attached to mounting bracket.



Transmitter weights

Model code (pos. 10)	Design type	Housing material of transmitter	Weight in kg (lb)
A, E	Remote	Aluminum	max. 4.4 (9.7)
J		Stainless steel	12.5 (27.6)

6 Electrical specification

6.1 Power supply

Power supply

Alternating-current voltage (rms):

- Power supply¹⁾: 24 V_{AC} +20 % -15 % or 100 – 240 V_{AC} +10 % -20 %
- Power frequency: 47 – 63 Hz

Direct-current voltage:

- Power supply¹⁾: 24 V_{DC} +20 % -15 % or 100 – 120 V_{DC} +8.3 % -10 %

¹⁾ for option MC₋ (DNV approval) supply voltage is limited to 24 V; in addition NE21 testing indicates a tolerable area of 24 V_{DC} ±20 % under NE21 test conditions.

Power consumption

P ≤ 10 W (including sensor)

Power supply failure

In the event of a power failure, the flow meter data are backed up on a non-volatile internal memory. In case of devices with display, the characteristic sensor values, such as nominal diameter, serial number, calibration constants, zero point, etc. and the error history are also stored on a microSD card.

Galvanic isolation

All circuits for inputs, outputs and power supply are galvanically isolated from each other.

6.2 Electrical interfaces

Depending on the selected interface protocol up to 4 in and/or outputs (I/O) are available, partially configurable.

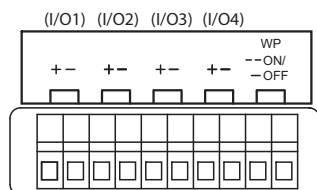
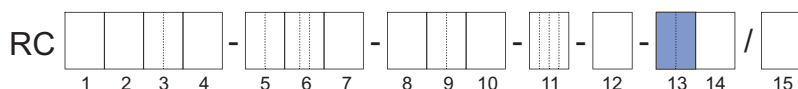

Model code position 13	Interface protocol	IO1 +/-	IO2 +/-	IO3 +/-	IO4 +/-
J ₋	HART	Active or Passive Analog Output + HART	Passive Pulse or Status Output	Configurable	Configurable
M ₋	Modbus	Configurable		Modbus	
G ₋ ¹⁾	PROFIBUS PA	PROFIBUS PA	Passive Pulse Output ²⁾	–	–
F ₋ ¹⁾	FOUNDATION Fieldbus	FOUNDATION Fieldbus		–	–

¹⁾Only with Ultimate Transmitter

²⁾For calibration purpose only

Details about in and outputs and communication interfaces are specified in the following chapters.

Spare Sensor I/O

Model code position 13	Specification
NN	Spare sensor without transmitter, all communication types and I/Os apply

6.2.1 Analog inputs and outputs

6.2.1.1 Analog outputs

Active current output *lout*

One or two current outputs are available depending on model code position 13. Depending on the measured value, the active current output delivers 4 – 20 mA.

It may be used for output of the following measured values for example.

- Flow rate (mass, volume, net partial component flow of a mixture)
- Density
- Temperature
- Pressure
- Concentration

NOTICE

Please see Software Instruction Manual IM 01U10S0_-00_-R for further details.

For HART communication devices, it is supplied on the current output *lout1*. The current output may be operated in compliance with the NAMUR NE43 standard.

	Value
Nominal output current range	4 – 20 mA
Maximum output current range	2.4 – 21.6 mA
Load resistance	≤ 750 Ω
Load resistance for secure HART communication	230 – 600 Ω

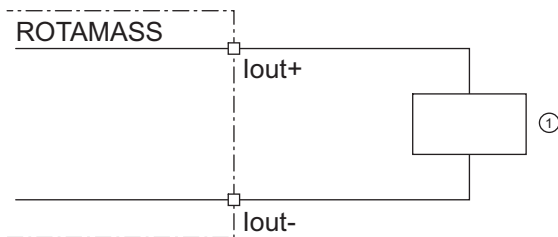

Fig. 19: Active current output connection *lout* HART

① Receiver

Passive current output *I_{out}*

	Value
Nominal output current range	4 – 20 mA
Maximum output current range	2.4 – 21.6 mA
External power supply	10.5 – 32 V _{DC}
Load resistance for secure HART communication	230 – 600 Ω
Load resistance at current output	≤ 911 Ω

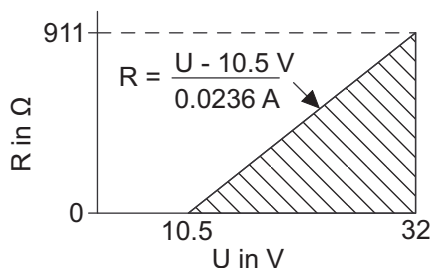

Fig. 20: Maximum load resistance as a function of an external power supply voltage

- R Load resistance
- U External power supply voltage

The diagram shows the maximum load resistance R as a function of voltage U of the connected voltage source. Higher load resistances are allowed with higher power supply values. The usable zone for passive power output operation is indicated by the hatched area.

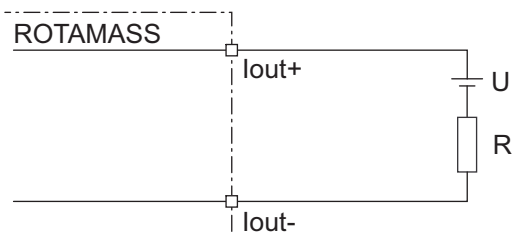

Fig. 21: Passive current output connection *I_{out}*

6.2.1.2 Analog inputs

Active current input *lin*

An individual analog power input is available for external analog devices.

The active current input *lin* is provided for connecting a two-wire transmitter with an output signal of 4 – 20 mA.

	Value
Nominal input current range	4 – 20 mA
Maximum input current range	2.4 – 21.6 mA
Internal power supply	24 V _{DC} ±20 %
Internal load resistance Rotamass	≤ 160 Ω

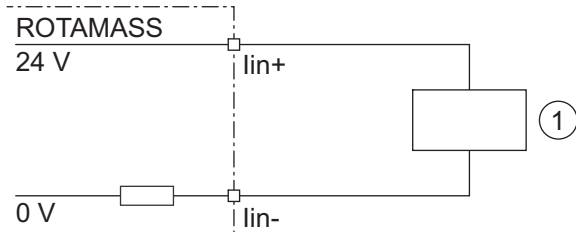

Fig. 22: Connection of external device with passive current output

① External passive current output device

Passive current input *lin*

The passive current input *lin* is provided for connecting a four-wire transmitter with an output signal of 4 – 20 mA.

	Value
Nominal input current range	4 – 20 mA
Maximum input current range	2.4 – 21.6 mA
Internal load resistance Rotamass	≤ 160 Ω

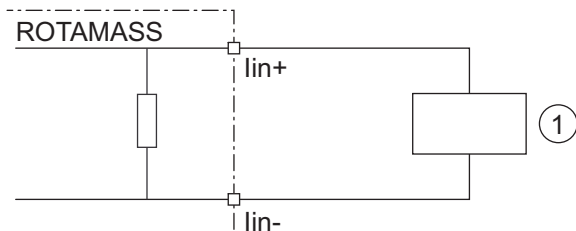

Fig. 23: Connection of external device with active current output

① External active current output device

6.2.2 Digital inputs and outputs

6.2.2.1 Digital outputs

Active pulse output *P/Sout*

Connection of an electronic counter

Maximum voltage and correct polarity must be observed for wiring.

Terms	Value
Load resistance	> 1 kΩ
Internal power supply	24 V _{DC} ±20 %
Maximum pulse rate	10000 pulses/s
Frequency range	0 – 12.5 kHz

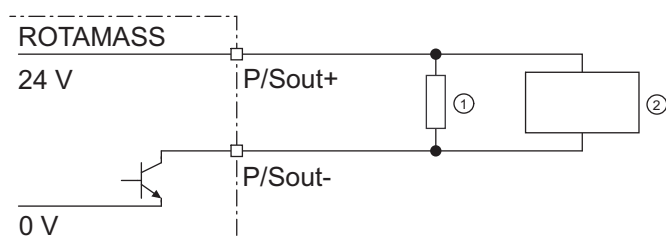

Fig. 24: Active pulse output connection *P/Sout*

- ① Load resistance
- ② Electronic counter

Connection of an electromechanical counter

Terms	Value
Maximum current	150 mA
Average current	≤ 30 mA
Internal power supply	24 V _{DC} ±20 %
Maximum pulse rate	2 pulses/s
Pulse width	20, 33, 50, 100 ms

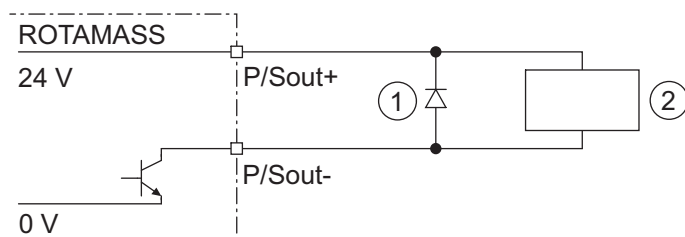

Fig. 25: Active pulse output *P/Sout* connection with electromechanical counter

- ① Protective diode
- ② Electromechanical counter

Active pulse output P/Sout with internal pull-up resistor

	Value
Internal power supply	24 V _{DC} ±20 %
Internal pull-up resistor	2.2 kΩ
Maximum pulse rate	10000 pulses/s
Frequency range	0 – 12.5 kHz

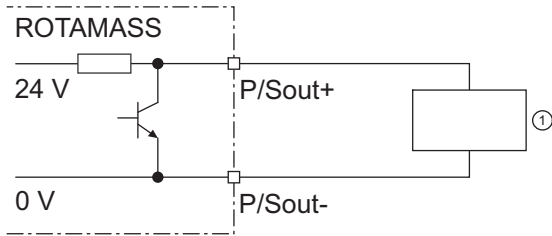

Fig. 26: Active pulse output P/Sout with internal pull-up resistor

- ① Electronic counter

Passive pulse output P/Sout

Maximum voltage and correct polarity must be observed for wiring.

	Value
Maximum load current	≤ 200 mA
Power supply	≤ 30 V _{DC}
Maximum pulse rate	10000 pulses/s
Frequency range	0 – 12.5 kHz

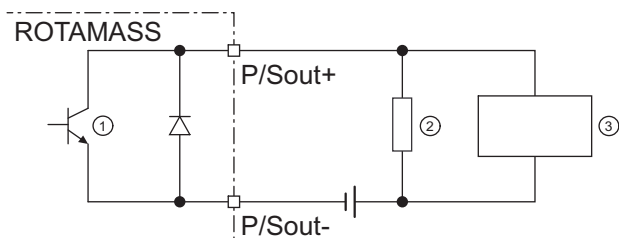

Fig. 27: Passive pulse output connection P/Sout with electronic counter

- ① Passive pulse or status output
- ② Load resistance
- ③ Electronic counter

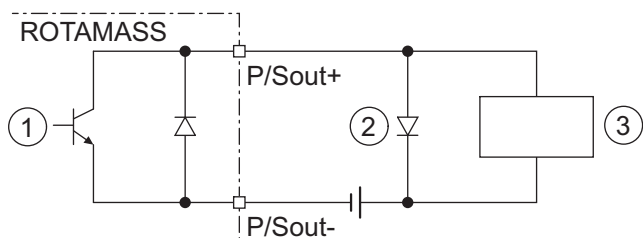

Fig. 28: Passive pulse output P/Sout connection with electromechanical counter

- ① Passive pulse or status output
- ② Protective diode
- ③ Electromechanical counter

Active status output P/Sout

Since this is a transistor contact, maximum allowed current as well as polarity and level of output voltage must be observed during wiring.

	Value
Load resistance	> 1 kΩ
Internal power supply	24 V _{DC} ±20 %

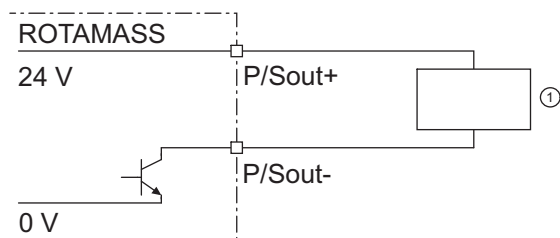

Fig. 29: Active status output connection P/Sout

① External device with load resistance

Active status output P/Sout with internal pull-up resistor

	Value
Internal pull-up resistor	2.2 kΩ
Internal power supply	24 V _{DC} ±20 %

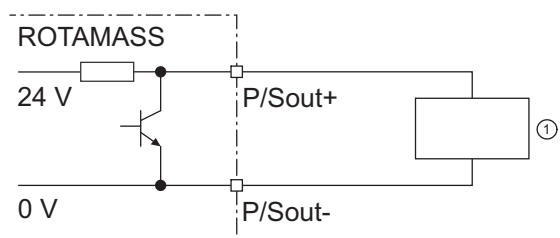

Fig. 30: Active status output P/Sout with internal pull-up resistor

① External device

Passive status output P/Sout or Sout

	Value
Output current	≤ 200 mA
Power supply	≤ 30 V _{DC}

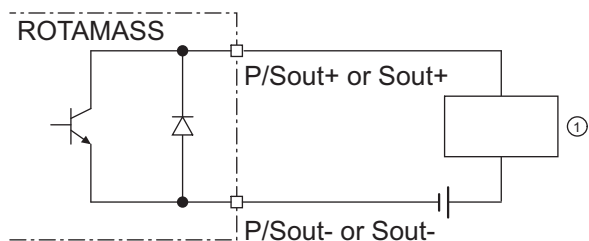

Fig. 31: Passive status output connection P/Sout or Sout

① External device

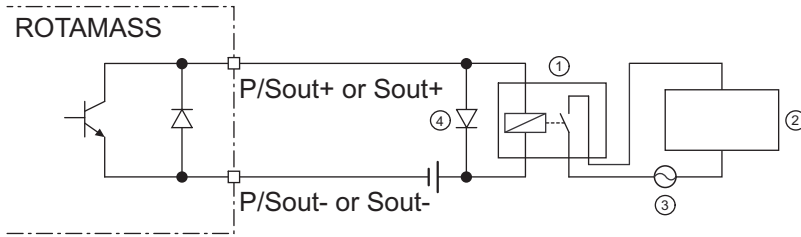

Fig. 32: Passive status output connection *P/Sout* or *Sout* for solenoid valve circuit

- ① Relay
- ② Solenoid valve
- ③ Magnetic valve power supply
- ④ Protective diode

A relay must be connected in series to switch alternating voltage.

Passive pulse or status output *P/Sout* (NAMUR)

Output signals according to EN 60947-5-6 (previously NAMUR, worksheet NA001):

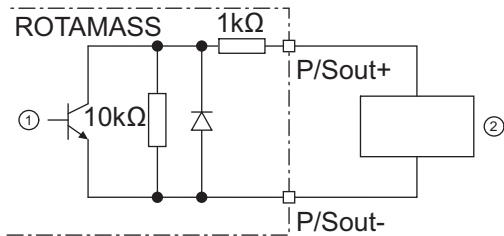

Fig. 33: Passive pulse or status output with switching amplifier connected in series

- ① Passive pulse or status output
- ② Switching amplifier

6.2.2.2 Digital inputs

Status input *Sin*



Do not connect a signal source with electric voltage.

The status input is provided for use of voltage-free contacts with the following specification:

Switching status	Resistance
Closed	< 200 Ω
Open	> 100 kΩ

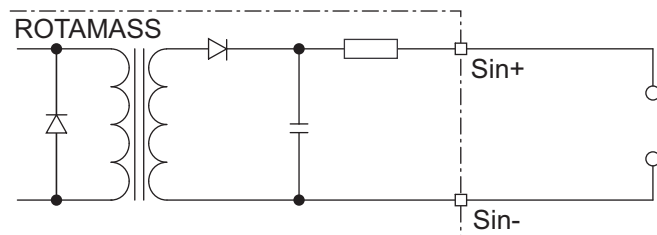

Fig. 34: Status input connection

6.2.3 HART

For HART communication devices, it is supplied on the current output Iout1. The current output may be operated in compliance with the NAMUR NE43 standard. HART is available with non-intrinsically and intrinsically safety outputs.

HART I/O

Model code position 13	Connection terminal assignment				
	I/O1 +/-	I/O2 +/-	I/O3 +/-	I/O4 +/-	WP
JA	Iout1 Active	P/Sout1 Passive	–	–	Write-protect
JB	Iout1 Active	P/Sout1 Passive	P/Sout2 Passive	Iout2 Active	Write-protect
JC	Iout1 Active	P/Sout1 Passive	Sin	Iout2 Active	Write-protect
JD	Iout1 Active	P/Sout1 Passive	Sout Passive	P/Sout2 Passive	Write-protect
JE	Iout1 Active	P/Sout1 Passive	Sin	P/Sout2 Passive	Write-protect
JF	Iout1 Active	P/Sout1 Passive	Sin	P/Sout2 Active Internal pull-up resistor	Write-protect
JG	Iout1 Active	P/Sout1 Passive	Sin	P/Sout2 Active	Write-protect
JH	Iout1 Active	P/Sout1 Passive	Iout2 Passive	Iin Active	Write-protect
JJ	Iout1 Active	P/Sout1 Passive	P/Sout2 Passive	Iin Active	Write-protect
JK	Iout1 Active	P/Sout1 Passive	Sin	Iin Active	Write-protect
JL	Iout1 Active	P/Sout1 Passive	Iout2 Passive	Iin Passive	Write-protect
JM	Iout1 Active	P/Sout1 Passive	P/Sout2 Passive	Iin Passive	Write-protect
JN	Iout1 Active	P/Sout1 Passive	Sin	Iin Passive	Write-protect

Iout1 Analog current output with HART communication

Iout2 Analog current output

Iin Analog current input

P/Sout1 Pulse or status output

P/Sout2 Pulse or status output

Sin Status input

Sout Status output

HART I/O intrinsically safe

Model code position 13	Connection terminal assignment				
	I/O1 +/-	I/O2 +/-	I/O3 +/-	I/O4 +/-	WP
JP	lout1 Passive	P/Sout1 Passive	lout2 Passive	–	Write-protect
JQ	lout1 Passive	P/Sout1 Passive	lout2 Passive	P/Sout2 Passive	Write-protect
JR	lout1 Passive	P/Sout1 Passive NAMUR	lout2 Passive	–	Write-protect
JS	lout1 Passive	P/Sout1 Passive NAMUR	lout2 Passive	P/Sout2 Passive NAMUR	Write-protect

- lout1 Analog current output with HART communication
- lout2 Analog current output
- P/Sout1 Pulse or status output
- P/Sout2 Pulse or status output

Intrinsically safe outputs are only available in combination with selecting Ex approval of the device, see model code position 11 in the table of chapter *Model code description* [▶ 86].

6.2.4 Modbus

Modbus interface is available with configurable I/O option.

Tab. 42: Connection terminal assignment for Modbus

Model code position 13	Connection terminal assignment						
	I/O1 +/-	I/O2 +/-	I/O3 +	I/O3 -	I/O4 +	I/O4 -	WP
M0	–	P/Sout1 Passive	–	Modbus C	Modbus B	Modbus A	Write-protect
M2	lin Active	P/Sout1 Passive	–	Modbus C	Modbus B	Modbus A	Write-protect
M3	P/Sout2 Passive	P/Sout1 Passive	–	Modbus C	Modbus B	Modbus A	Write-protect
M4	P/Sout2 Active	P/Sout1 Passive	–	Modbus C	Modbus B	Modbus A	Write-protect
M5	P/Sout2 Active Internal pull-up resistor	P/Sout1 Passive	–	Modbus C	Modbus B	Modbus A	Write-protect
M6	lout1 Active	P/Sout1 Passive	–	Modbus C	Modbus B	Modbus A	Write-protect
M7	lin Passive	P/Sout1 Passive	–	Modbus C	Modbus B	Modbus A	Write-protect

- lout Analog current output, no HART
- lin Analog current input
- P/Sout1 Pulse or status output
- P/Sout2 Pulse or status output

Output Signal

Digital communication signal according to EIA485 standard (RS485).

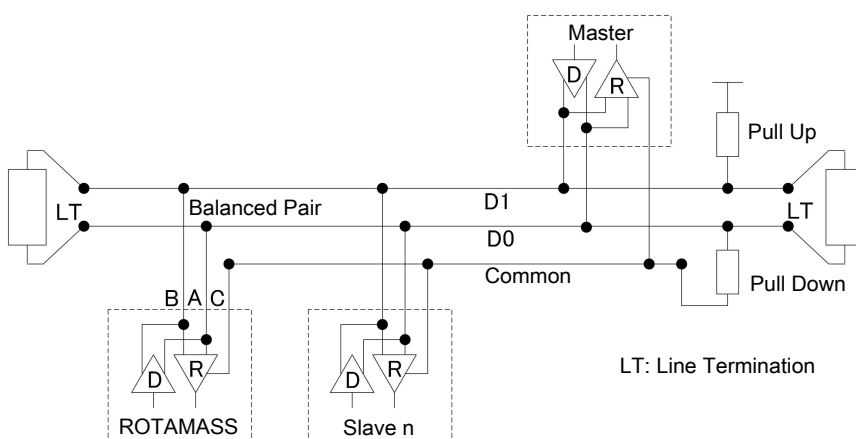

6.2.5 PROFIBUS PA

PROFIBUS PA interface is available with and without intrinsically safety.

Model code position 13	Connection terminal assignment				
	I/O1 +/-	I/O2 +/-	I/O3 +/-	I/O4 +/-	WP
G0	PROFIBUS PA	Pulse Passive	–	–	Write-protect
G1	PROFIBUS PA (IS)	Pulse Passive (IS)	–	–	Write-protect

PROFIBUS PA PA communication
 Pulse Passive Pulse / Frequency output

Intrinsically safe (IS) outputs are only available in combination with selecting Ex approval of the device, see model code position 11 of the table in chapter *Model code description* [▶ 86].

Output Signal

Digital communication signal according to IEC 61158/61784.

Maximum voltage and correct polarity must be observed for wiring.

	Value
Power supply	9 – 32 V _{DC}
Current draw	15 mA (maximum)

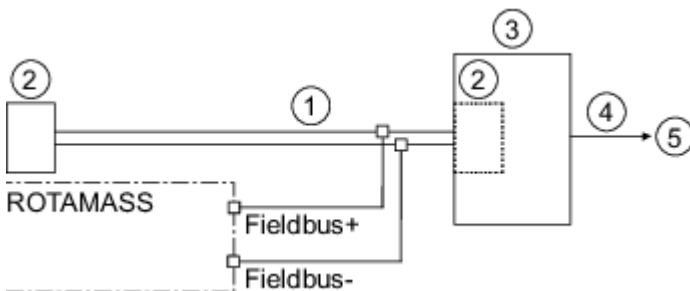

Fig. 35: PROFIBUS PA connection

- ① PROFIBUS PA
- ② Termination
- ③ DP/PA-Coupler
- ④ PROFIBUS DP
- ⑤ HOST

Supported Functions

Profile PA Rev. 3.02 compliant, supporting:

- Condensed Status (NE107)
- Device identification number (IDENT_NUMBER) adaption

Function Blocks	Description	
Transducer	FTB	Flow
	CTB	Concentration
	LTB	LCD Indicator
	MTB	Maintenance
	ADTB	Advanced Diagnostics
Analog Input ¹⁾	AI1	Mass flow
	AI2	Density
	AI3	Temperature
	AI4	Volume flow
	AI5	Reference density
	AI6	Corrected volume flow
Totalizer ¹⁾	TOT1	Mass
	TOT2	Volume
	TOT3	Corrected volume
Analog Output ¹⁾	AO	Pressure

¹⁾Factory default setting. Assignment can be changed by parameter "channel".

ID	Description	Device description file (GSD)	Applicable function blocks						
			AI1	AI2	AI3	AI4-6	TOT1	TOT2-3	AO
0x45A0	Manufacturer specific	YEC45A0.gsd	•	•	•	•	•	•	•
0x9740	Profile specific	pa139740.gsd	•				•		
0x9741		pa139741.gsd	•	•			•		
0x9742		pa139742.gsd	•	•	•		•		

meaning of "•": available

6.2.6 FOUNDATION Fieldbus

FOUNDATION Fieldbus interface is available with and without intrinsically safety.

Functions overview

Model code position 13	Connection terminal assignment				
	I/O1 +/-	I/O2 +/-	I/O3 +/-	I/O4 +/-	WP
F0	FOUNDATION Fieldbus	Pulse Passive	–	–	Write-protect
F1	FOUNDATION Fieldbus (IS)	Pulse Passive (IS)	–	–	Write-protect

Intrinsically safe (IS) outputs are only available in combination with selecting Ex approval of the device, see model code position 11 in the table of chapter *Model code description* [▶ 86].

Output Signal

Digital communication signal according to IEC 61158/61784.

Maximum voltage and correct polarity must be observed for wiring.

	Value
Power supply	9 – 32 V _{DC}
Current draw	15 mA (maximum)

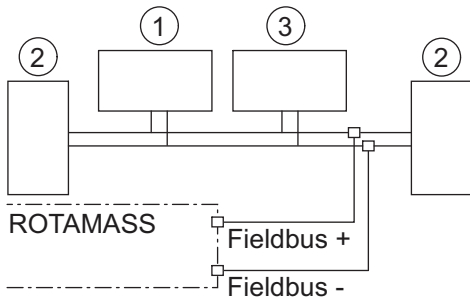

Fig. 36: FOUNDATION Fieldbus connection

- ① Fieldbus power supply and condition
- ② Termination
- ③ HOST

Supported Functions

Compliance to ITK6.3:

Function Blocks	Description	
Transducer	FCB	Flow
	CTB	Concentration
	LTB	LCD Indicator
	MTB	Maintenance
	ADTB	Advanced Diagnostics
Analog Input	AI1	Mass flow
	AI2	Density
	AI3	Temperature
	AI4	Volume flow
	AI5	Reference density
	AI6	Corrected volume flow
Integrator	IT	Depends on FOUNDATION Fieldbus configuration (up to 3)
Multi Analog Output	MAO	Depends on FOUNDATION Fieldbus configuration

ID	Description
594543	Manufacturer
0013	Device Type

6.3 Display and microSD card

Display attributes	Specifications	Model code position 14
Type	4-line dot-matrix display	1
Resolution	128(W) x 64 (H) dots	
Size	64.6 mm x 31.2 mm	
Control	via IR switches	

All of the functions described here are also available via digital communication. Numerical values that are entered via the display are limited to 6 digits for process variables and 8 digits for totalizer.

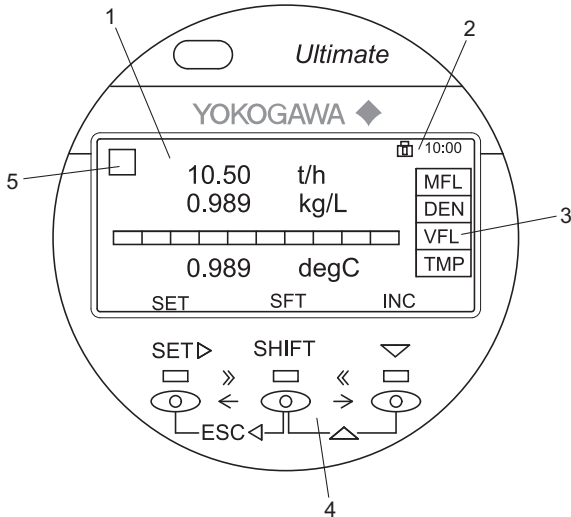

Fig. 37: Display layout

- | | | | |
|---|--------------------------------|---|--------------|
| 1 | Measured quantities and units | 4 | IR switches |
| 2 | Status icon and time | 5 | Alarm symbol |
| 3 | Measured quantity abbreviation | | |

The controls on the display are IR switches. They respond as soon as an object, such as a finger, is in close proximity. It is not necessary to apply pressure to the display surface.



Display unit

The display unit includes a slot for the microSD card.

SD card attributes	Specifications
Type	Industrial Grade microSD card
SD specification	Compliant with SD Specification version 2.0
Physical dimension	15 mm x 11 mm x 1.0 mm (+/-0.1 mm)
Capacity	1 GB
Seq. Read (MB/s)	24.01
Seq. Write (MB/s)	17.96



It is recommended to use the microSD card included with the Rotamass Total Insight. Functionality of the device cannot be guaranteed if other cards are used.

For status icon placement on the display see figure at *Display* [▶ 76], No. 1, 2 or 5.

6.4 Cable specifications

For remote type devices, a connecting cable has to be used to connect the sensor to the transmitter. The device specifications, stated in this document, are valid only if one of the original Rota Yokogawa connecting cables is used.

Cable length limitations to be considered:

Cable type	Option code	Maximum length to keep the specification	Maximum allowable length in hazardous areas
Standard connecting cable	L_...	30 m	171 m
Fire retardant connecting cable with DNV certificate	Y_...	30 m	95 m

Cables longer than 30 m must be ordered as separate item. For this purpose please check the “Customer Maintenance Parts List” (CMPL 01U10B01-00EN-R) or consult our Yokogawa Service team.

7 Approvals and declarations of conformity

CE marking

The Rotamass Total Insight meets the statutory requirements of the applicable EU Directives. By attaching the CE mark, Rota Yokogawa confirms conformity of the field instrument with the requirements of the applicable EU Directives. The EU Declaration of Conformity is enclosed with the product on a data carrier.

Pressure equipment approvals

The Rotamass Total Insight is in compliance with the statutory requirements of the applicable EU Pressure Equipment Directive (PED) for fluid groups 1 and 2.

The customer is fully responsible of selecting proper materials which withstand corrosive or erosive conditions. In case of heavy corrosion and/or erosion the instrument may not withstand the pressure and an incident may happen with human and/or environmental harm. Yokogawa will not take any liability regarding damage caused by corrosion or erosion. If corrosion or erosion may happen, the user has to check periodically if the necessary wall thickness is still in place.

RoHS and WEEE Intended Use

Rotamass Total Insight flow meter is intended to be sold and used in large-scale stationary industrial applications, large-scale fixed installation, means of transport vehicles for persons or goods, excluding two-wheel vehicles which are not type approved. The instrument should be disposed in accordance with applicable national legislations or regulations, respectively.

Details about all standards that are fulfilled are show in the tables below.

Not all options are available in all countries. For details please contact your local Yokogawa Sales Organization.

7.1 Legal equipment standards and norms

Legal equipment standards and norms

Approval type	Approval or certificate
Electromagnetic Compatibility (EMC)	EU directive 2014/30/EU per EN 61326-1 Class A Table 2 and EN 61326-2-3 and EN 61328-2-5 (PROFIBUS PA, FOUNDATION Fieldbus)
	RCM in Australia/New Zealand: Rotamass Total Insight meets the EMC requirements of the Australian Communications and Media Authority (ACMA).
	KC mark in Korea
	TR CU 020 in EAEU area
	CMIM mark in Morocco
	UKCA mark in Great Britain
Low Voltage	EU directive 2014/35/EU (LVD) per: <ul style="list-style-type: none"> ▪ EN 61010 1 ▪ EN 61010 2 030
	TR CU 004 in EAEU area
	CMIM mark in Morocco
	UKCA mark in Great Britain
	ANSI/UL 61010-1
	CAN/CSA-C22.2 N0. 61010-1/US)
Pressure Equipment	EU directive 2014/68/EU per AD 2000 Code (PED)
	ASME B31.3 compliance
	TR CU 032 in EAEU area
	CRN registered in Canada
	UKCA mark in Great Britain
	ANSI/UL 61010-1 Annex G
	CAN/CSA-C22.2 N0. 61010-1 Annex G
	Licensing rules for special equipment and charging units TSG 07 Pressure pipe supervision inspection rules TSG D7006
RoHS	EU Directives 2011/65/EU, 2015/863/EU per EN IEC 63000
	China RoHS
	Environmental Conditions; compliance to ISA-71.04G standard

7.2 Application and industry related standards

General industrial standards

Approval type	Approval or certificate
NAMUR	<ul style="list-style-type: none"> EMC according to NE 21 Homologation according to NE 95 Mounting length according to NE 132
NACE	<p>Chemical composition of wetted materials 316L/316/1.4404/1.4401/1.4435 and Ni-Alloy C-22/2.4602 is conform to:</p> <ul style="list-style-type: none"> ANSI / NACE-MR0175 / ISO15156-2 ANSI / NACE-MR0175 / ISO15156-3 NACE MR0103 <p>For details please see Rota Yokogawa declaration about NACE conformity 8660001.</p>

Marine approvals

Approval type	Approval or certificate
IMO	Material Declaration and Ship recycling compliances to IMO Resolution MEPC.269 (68)
DNV	<p>Marine type approval according to DNV Type approval scheme DNV-CP-0338 and EU RO Mutual Recognition type approval required by article 10.1 of EU regulation 391/2009.</p> <p>For thermal oil applications please consider X-ray inspection (option /RT or /RTA); see [86].</p>
KR	Marine type approval according to KR Rules for Classification of Steel Ships Pt.6, Ch.2, Art.301
ABS	<p>Product device assessment according to ABS rules for building and classing</p> <ul style="list-style-type: none"> Marine Vessels 4-8-3/1.7, 1.9, 1.11.1, 1.17.1 & 13.1, 4-8-4/27.1, 4-9-9/13.1, 13.5 and Table 1 Offshore units 4-3-1/9, 11, 15 & 17.1, 4-3-3/9.1.1 and 9.1.2
LR	Marine type approval according to LR test specification

Functional Safety

Approval type	Approval or certificate
SIL	<p>Exida Certificate per IEC61508:2010 Parts 1-7</p> <p>SIL 2 @ HFT=0; SIL 3 @ HFT =1</p> <p>for both 4...20 mA analog outputs</p>

Metrology Regulations

Approval type	Approval or certificate
NTEP	Compliance with NIST Handbook 44 Requirements. Certificate number: 21-069
ISO	Measurement of fluid flow in closed conduits. Guidance to the selection, installation and use of Coriolis flowmeters (mass flow, density and volume flow measurements) according to Manufacturer Declaration: ISO 10790
Local type approvals	<p>Rotamass Total Insight is registered as a measuring instrument in the following countries:</p> <ul style="list-style-type: none"> China Russia Belarus Kazakhstan Uzbekistan <p>Please contact your Yokogawa representative regarding respective “Pattern Approval Certificate of Measuring Instruments” and for export to these countries.</p>

7.3 Communication interface standards

Communication interface standards

Approval type	Approval or certificate
HART	Registered at FieldComm Group
FOUNDATION Fieldbus	Registered at FieldComm Group acc. to ITK 6
PROFIBUS PA	Certified at PROFIBUS Nutzerorganisation e.V acc. to PA-Profile 3.02

7.4 Other standards and guidelines

Other standards and guidelines

Approval type	Approval or certificate
IGC	Intergranular Corrosion testing of wetted parts according EN ISO 3651-2 and ASTM. IGC test and certificate available with option P6.
WEEE	EU directive 2012/19/EU (Waste Electrical and Electronic Equipment) is only valid in the European Economic Area.

7.5 Hazardous area

Ex approvals: All data relevant for explosion protection are included in separate Explosion Proof Type Manuals.

Approval type	Approval or certificate
ATEX	EU Directive 2014/34/EU ATEX approval: DEKRA 15ATEX0023 X CE ₀₃₄₄ II2G or II2(1)G or II2D or II2(1)D Applied standards: <ul style="list-style-type: none"> ▪ EN IEC 60079-0 ▪ EN 60079-1 ▪ EN 60079-7 ▪ EN 60079-11 ▪ EN 60079-31
IECEX	IECEx approval: IECEx DEK 15.0016X Applied standards: <ul style="list-style-type: none"> ▪ IEC 60079-0 ▪ IEC 60079-1 ▪ IEC 60079-7 ▪ IEC 60079-11 ▪ IEC 60079-31
FM (CA/US)	FM approvals: <ul style="list-style-type: none"> ▪ US Cert No. FM16US0095X ▪ CA Cert No. FM16CA0031X Applied standards: <ul style="list-style-type: none"> ▪ Class 3600 ▪ Class 3610 ▪ Class 3615 ▪ Class 3616 ▪ Class 3810 ▪ ANSI/UL 60079-0 ▪ ANSI/UL 60079-11 ▪ ANSI/UL 61010-1 ▪ ANSI/NEMA 250 ▪ ANSI/IEC 60529 ▪ UL 122701 ▪ CSA-C22.2 No. 0.4 ▪ CSA-C22.2 No. 0.5 ▪ CSA-C22.2 No. 25 ▪ CSA-C22.2 No. 30 ▪ CSA-C22.2 No. 94.1 ▪ CSA-C22.2 No. 94.2 ▪ CSA-C22.2 No. 60079-0 ▪ CSA-C22.2 No. 60079-11 ▪ CSA-C22.2 No. 61010-1 ▪ CSA-C22.2 No. 60529

Approval type	Approval or certificate
INMETRO (BR)	INMETRO approval: DEKRA 16.0012X Applied standards: <ul style="list-style-type: none"> ▪ ABNT NBR IEC 60079-0 ▪ ABNT NBR IEC 60079-1 ▪ ABNT NBR IEC 60079-7 ▪ ABNT NBR IEC 60079-11 ▪ ABNT NBR IEC 60079-31
NEPSI (CN)	NEPSI approval: GYJ22.1889X Applied standards: <ul style="list-style-type: none"> ▪ GB/T 3836.1 ▪ GB/T 3836.2 ▪ GB/T 3836.3 ▪ GB/T 3836.4 ▪ GB/T 3836.31
PESO (IN)	PESO approval: PESO approval is based on ATEX certification by DEKRA DEKRA 15ATEX0023 X PESO approval is only valid for type of protection “d” flameproof enclosure. Option Q11 must be ordered for conformity of device with PESO requirements. Equipment Reference Numbers: P585538/1 P585538/2 P585538/3 P585538/4 Applied standards: <ul style="list-style-type: none"> ▪ EN IEC 60079-0 ▪ EN 60079-1 ▪ EN 60079-11
Safety Label (TW)	Please refer to IECEx approval for specifications. A device with IECEx approval (model code position 11, value: SF2_) must be ordered to comply with Safety Label requirements. For export to Taiwan and to get the Safety Label the Yokogawa representative in Taiwan must be contacted in advance. Identification Number: TD04000C

Approval type	Approval or certificate
Korea Ex	<p>Korea Ex certificates:</p> <ul style="list-style-type: none"> ▪ 18-KA4BO-0507X ▪ 18-KA4BO-0508X ▪ 18-KA4BO-0513X ▪ 18-KA4BO-0526X ▪ 18-KA4BO-0509X ▪ 18-KA4BO-0510X ▪ 18-KA4BO-0539X ▪ 18-KA4BO-0540X ▪ 18-KA4BO-0541X ▪ 18-KA4BO-0681X ▪ 18-KA4BO-0542X ▪ 18-KA4BO-0682X ▪ 18-KA4BO-0527X ▪ 18-KA4BO-0528X ▪ 18-KA4BO-0531X ▪ 18-KA4BO-0532X ▪ 18-KA4BO-0533X ▪ 18-KA4BO-0534X ▪ 18-KA4BO-0537X ▪ 18-KA4BO-0538X <p>Applied standards:</p> <p>Notice of Ministry of Labor No 2016-54 harmonized with</p> <ul style="list-style-type: none"> ▪ IEC 60079-0 ▪ IEC 60079-1 ▪ IEC 60079-7 ▪ IEC 60079-11 ▪ IEC 60079-31
EAC Ex	<p>RU C-DE.AA87.B.01213/23</p> <p>Applied standards:</p> <ul style="list-style-type: none"> ▪ Gost 31610.11-2014 (IEC 60079-11:2011) ▪ Gost IEC 60079-1-2013 ▪ Gost IEC 60079-31-2013 ▪ Gost 31610.7-2017 (IEC 60079-7:2015) ▪ Gost 31610.0-2019 (IEC 60079-0:2017)

Approval type	Approval or certificate
Japan Ex	Japan Ex certificates: <ul style="list-style-type: none"> ▪ DEK 18.0053 X ▪ DEK 18.0054 X ▪ DEK 18.0055 X ▪ DEK 18.0056 X ▪ DEK 18.0057 X ▪ DEK 18.0060 X ▪ DEK 21.0061 X ▪ DEK 18.0062 X ▪ DEK 18.0063X ▪ DEK 18.0064 X ▪ DEK 18.0069 X ▪ DEK 18.0070 X ▪ DEK 18.0071 X ▪ DEK 18.0072 X ▪ DEK 18.0073 X ▪ DEK 18.0078 X ▪ DEK 18.0079 X ▪ DEK 18.0080 X ▪ DEK 18.0081 X ▪ DEK 18.0082 X ▪ DEK 18.0087 X Applied standards: <ul style="list-style-type: none"> ▪ JNIO SH-TR-46-1: 2015 ▪ JNIO SH-TR-46-2: 2018 ▪ JNIO SH-TR-46-6: 2015
UKEx	UKEx approval: DEKRA 21UKEX0356X CE ₈₅₀₅ II2G or II2(1)G or II2D or II2(1)D
ECAS Ex	24-05-111617/E24-05-115213/NB0010
Ukraine Ex	DEKRA 15ATEX0023 X

8 Ordering information

8.1 Model code description

The model code of the Rotamass Total Insight is explained below.

Items 1 through 14 are mandatory entries and must be specified at the time of ordering.

Device options (item 15) can be selected and specified individually by separating them with slashes.

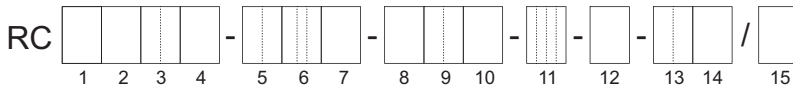

Basic model code (pos. 1-4)

Model code position	Model code	Description
Transmitter		
1	E	Essential (base function)
1	U	Ultimate (high function)
1	N	Spare sensor without transmitter, combinable with Rotamass TI transmitter
Sensor		
2	P	Prime
Meter size		
3	25	Nominal mass flow: 1.6 t/h (59 lb/min), Maximum mass flow: 2.3 t/h (85 lb/min)
3	40	Nominal mass flow: 4.7 t/h (170 lb/min) Maximum mass flow: 7 t/h (260 lb/min)
3	50	Nominal mass flow: 20 t/h (730 lb/min) Maximum mass flow: 29 t/h (1100 lb/min)
3	80	Nominal mass flow: 51 t/h (1900 lb/min) Maximum mass flow: 76 t/h (2800 lb/min)
3	1H	Nominal mass flow: 170 t/h (6200 lb/min) Maximum mass flow: 255 t/h (9400 lb/min)
Material wetted parts		
4	S	Stainless steel 1.4404/316L

Model code positions 5-14 (Mandatory items)

Model code position	Model code	Description
Process connection size		
5	15	DN15, ½ in.
5	20	DN20, ¾ in.
5	25	DN25, 1 in.
5	40	DN40, 1½ in.
5	50	DN50, 2 in.
5	65	DN65, 2½ in.
5	80	DN80, 3 in.
5	1H	DN100, 4 in.

Model code position	Model code	Description
5	1Q	DN125, 5 in.
Process connection type		
6	BA1	ASME flange class 150, compatible to ASME B16.5, raised face (RF)
6	BA2	ASME flange class 300, compatible to ASME B16.5, raised face (RF)
6	BA4	ASME flange class 600, compatible to ASME B16.5, raised face (RF)
6	CA4	ASME flange class 600, compatible to ASME B16.5, ring joint (RJ)
6	BD4	EN flange PN 40, compatible to EN 1092-1 type B1, raised face (RF)
6	GD4	EN flange PN 40, compatible to EN 1092-1 type D, with groove
6	ED4	EN flange PN 40, compatible to EN 1092-1 type E, with spigot
6	FD4	EN flange PN 40, compatible to EN 1092-1 type F, with recess
6	BD6	EN flange PN 100, compatible to EN 1092-1 type B1, raised face (RF)
6	GD6	EN flange PN 100, compatible to EN 1092-1 type D, with groove
6	ED6	EN flange PN 100, compatible to EN 1092-1 type E, with spigot
6	FD6	EN flange PN 100, compatible to EN 1092-1 type F, with recess
6	BJ1	JIS flange 10K, compatible to JIS B 2220
6	BJ2	JIS flange 20K, compatible to JIS B 2220
6	BP1	JPI flange class 150
6	BP2	JPI flange class 300
6	BP4	JPI flange class 600
6	TG9	Process connection with internal thread G
6	TT9	Process connection with internal thread NPT
Sensor housing material		
7	0	Stainless steel 1.4301/304, 1.4404/316L
Process fluid temperature range		
8	0	Standard Temperature range
Mass flow and density accuracy		
9	E7	Liquid: 0.2 % maximum mass flow deviation, 4 g/l density deviation
9	E3	Liquid: 0.2 % maximum mass flow deviation, 1 g/l density deviation
9	E2	Liquid: 0.2 % maximum mass flow deviation, 0.5 g/l density deviation
9	D7	Liquid: 0.15 % maximum mass flow deviation, 4 g/l density deviation
9	D3	Liquid: 0.15 % maximum mass flow deviation, 1 g/l density deviation
9	D2	Liquid: 0.15 % maximum mass flow deviation, 0.5 g/l density deviation
9	C7	Liquid: 0.1 % maximum mass flow deviation, 4 g/l density deviation
9	C3	Liquid: 0.1 % maximum mass flow deviation, 1 g/l density deviation
9	C2	Liquid: 0.1 % maximum mass flow deviation, 0.5 g/l density deviation
9	70	Gas: 0.75 % maximum mass flow deviation
9	50	Gas: 0.50 % maximum mass flow deviation
9	30	Gas: 0.35 % maximum mass flow deviation
Design and housing		
10	0	Integral type with "urethane-cured polyester powder coating" coated aluminum transmitter housing
10	2	Integral type with "corrosion protection coating" coated aluminum transmitter housing
10	A	Remote type with "urethane-cured polyester powder coating" coated aluminum transmitter housing and standard neck sensor
10	E	Remote type with "corrosion protection coating" coated aluminum transmitter housing and standard neck sensor

Model code position	Model code	Description
10	J	Remote type stainless steel transmitter and standard neck sensor
Ex approval		
11	NN00	None
11	KF21	ATEX, explosion group IIC and IIIC
11	KF22	ATEX, explosion group IIB and IIIC
11	SF21	IECEx, explosion group IIC and IIIC
11	SF22	IECEx, explosion group IIB and IIIC
11	FF11	FM, groups A, B, C, D, E, F, G
11	FF12	FM, groups C, D, E, F, G
11	UF21	INMETRO, explosion group IIC and IIIC
11	UF22	INMETRO, explosion group IIB and IIIC
11	NF21	NEPSI, explosion group IIC and dust proof
11	NF22	NEPSI, explosion group IIB and dust proof
11	GF21	EAC Ex, explosion group IIC and IIIC
11	GF22	EAC Ex, explosion group IIB and IIIC
11	PF21	Korea Ex, explosion group IIC and IIIC
11	PF22	Korea Ex, explosion group IIB and IIIC
11	JF53	Japan Ex, Temperature class T3, gas group IIC
11	JF54	Japan Ex, Temperature class T4, gas group IIC
11	BF21	UKEx, explosion group IIC and IIIC
11	BF22	UKEx, explosion group IIB and IIIC
Cable entries		
12	2	ANSI ½ in. NPT
12	4	ISO M20x1.5
Communication type and I/O		
13	JA	1 active current output HART, 1 passive pulse or status output
13	JB	2 active current outputs one with HART, 2 passive pulse or status outputs
13	JC	2 active current outputs one with HART, 1 passive pulse or status output, 1 voltage-free status input
13	JD	1 active current output HART, 2 passive pulse or status outputs, 1 passive status output
13	JE	1 active current output HART, 2 passive pulse or status outputs, 1 voltage-free status input
13	JF	1 active current output HART, 1 passive pulse or status output, 1 active pulse or status output with pull-up resistor, 1 voltage-free status input
13	JG	1 active current output HART, 1 passive pulse or status output, 1 active pulse or status output, 1 voltage-free status input
13	JH	1 active current output HART, 1 passive pulse or status output, 1 passive current output, 1 active current input
13	JJ	1 active current output HART, 2 passive pulse or status outputs, 1 active current input
13	JK	1 active current output HART, 1 passive pulse or status output, 1 voltage-free status input, 1 active current input
13	JL	1 active current output HART, 1 passive pulse or status output, 1 passive current output, 1 passive current input
13	JM	1 active current output HART, 2 passive pulse or status outputs, 1 passive current input

Model code position	Model code	Description
13	JN	1 active current output HART, 1 passive pulse or status output, 1 voltage-free status input, 1 passive current input
13	JP	2 passive current outputs one with HART, 1 passive pulse or status output
13	JQ	2 passive current outputs one with HART, 2 passive pulse or status outputs
13	JR	2 passive current outputs one with HART, 1 passive Namur pulse or status output
13	JS	2 passive current outputs one with HART, 2 passive Namur pulse or status outputs
13	F0	FOUNDATION Fieldbus, 1 passive pulse output
13	F1	FOUNDATION Fieldbus, intrinsically safe, 1 passive pulse output
13	M0	Modbus output, 1 passive pulse or status output
13	M2	Modbus output, 1 passive pulse or status output, 1 active current input
13	M3	Modbus output, 2 passive pulse or status outputs
13	M4	Modbus output, 1 passive pulse or status output, 1 active pulse or status output
13	M5	Modbus output, 1 passive pulse or status output, 1 active pulse or status output with pull-up resistor
13	M6	Modbus output, 1 passive pulse or status output, 1 active current output
13	M7	Modbus output, 1 passive pulse or status output, 1 passive current input
13	G0	Profibus PA, 1 passive pulse output
13	G1	Profibus PA, intrinsically safe, 1 passive pulse output
13	NN	Spare sensor without transmitter, all communication types and I/Os apply
Display		
14	0	No display
14	1	With display
14	N	Spare sensor without transmitter, no display applied

Model code position 15 (device options)

In general, the selection of one option per option group is possible. In option group „Calibration certificate“ all 3 options can be combined.

Model code position	Model code	Description
Additional nameplate information		
15	/BG	Customer-specific tag number on nameplate
Pre-setting of customer parameters		
15	/PS	Presetting of selected parameters based on customer data
Country-specific delivery		
15	/PJ	Delivery to Japan incl. SI units pre-setting and Quality Inspection Certificate (EN/JP)
15	/CN	Delivery to China including China RoHS mark
15	/KC	Delivery to Korea including KC mark
15	/VE	Delivery to EAEU area including EAC mark
15	/VB	Delivery to EAEU area including EAC mark and Belarussia Pattern Approval mark
15	/VR	Delivery to EAEU area including EAC mark and Russia Pattern Approval mark
15	/UK	Delivery to UK including UKCA mark

Model code position	Model code	Description
Country-specific application		
15	/Q11	PESO approval delivery
15	/QR2	Kazakhstan Pattern Approval mark and Primary verification, including certificate
15	/QR3	Uzbekistan Pattern Approval and Primary verification
15	/TS1	China TSG Approval Pressure Class GC1
15	/TS2	China TSG Approval Pressure Class GC2
15	/CS	CRN (Canadian Registration Number)
Concentration and Petroleum measurement		
15	/CST	Standard concentration measurement
15	/AC0	Advanced concentration measurement, customer settings
15	/AC1	Advanced concentration measurement, one default data set
15	/AC4	Advanced concentration measurement, four default data sets
15	/C52	Net Oil Computing (NOC) following API standard
Customer-specific calibration		
15	/K2	Customer-specific 5-point mass flow calibration with measuring range on factory calibration certificate (mass flow or volume flow of water). A table listing the desired calibration points must be supplied with the order.
15	/K5	Customer-specific 10-point mass flow calibration with measuring range on DAkkS calibration certificate (mass flow or volume flow of water). A table listing the desired calibration points must be supplied with the order.
Accordance with terms of order		
15	/P2	Declaration of compliance with the order 2.1 according to EN 10204
15	/P3	Inspection certificate 3.1 according to EN 10204 (Quality Inspection Certificate). Declaration of compliance with the order including inspection results.
Material certificates		
15	/P6	Certificate of Marking Transfer and Raw Material Certificates (Inspection Certificate 3.1 according to EN 10204), including IGC and conform to NACE MR0175 and MR0103. For details and exceptions please refer to Rota Yokogawa declaration about NACE conformity, document no. 8660001.
Pressure testing		
15	/P8	Hydrostatic Pressure Test Certificate (Inspection Certificate 3.1 according to EN 10204)
Surfaces free of oil and grease		
15	/H1	Degreasing of wetted surfaces according to ASTM G93/G93M-19 (Level C), including test report

Model code position	Model code	Description
Welding certificate		
15	/WP	Welding certificates for butt welding between process connection and flow divider: <ul style="list-style-type: none"> ▪ WPS according to DIN EN ISO 15609-1 ▪ WPQR according to DIN EN ISO 15614-1 ▪ WQC according to DIN EN 287-1 or DIN EN ISO 6906-4
15	/WPA	Welding procedures and certificate according ASME IX for butt welding between process connection and flow divider: <ul style="list-style-type: none"> ▪ WPS ▪ WPQR ▪ WQP
Calibration certificate		
15	/L2	The certificate confirms that the delivered instrument has undergone a calibration traceable to national standards, including a list of working standards used for calibration. Language: English/Japanese
15	/L3	The certificate confirms that the delivered instrument has undergone a calibration traceable to national standards, including a list of primary standards to which the delivered product is traceable. Language: English/Japanese
15	/L4	The certificate confirms that the delivered instrument has undergone a calibration traceable to national standards and that the calibration system of Rota Yokogawa is traceable to national standards. Language: English/Japanese
ASME B31.3 compliance		
15	/P15	ASME B31.3 compliance NORMAL FLUID SERVICE
X-ray inspection of flange weld seam		
15	/RT	X-ray inspection of flange weld seam according to DIN EN ISO 17636-1/B. Evaluation according to AD2000HP 5/3 and DIN EN ISO 5817/C, including certificate
15	/RTA	X-ray inspection according ASME V
Positive Material Identification of wetted parts		
15	/PM	Positive Material Identification of wetted parts, including certificate (Inspection Certificate 3.1 according to EN 10204)
Dye penetrant test of weld seams		
15	/PT	Dye penetrant test of process connection weld seams according to DIN EN ISO 3452-1, including certificate
15	/PTA	Dye penetrant test of flange welding according to ASME V, including certificate
Combined certificate		
15	/P10	Combination of: <ul style="list-style-type: none"> ▪ P3: Quality Inspection Certificate ▪ P6: Certificate of Marking Transfer and Raw Material Certificates ▪ P8: Hydrostatic Pressure Test Certificate
15	/P11	Combination of: <ul style="list-style-type: none"> ▪ P3: Quality Inspection Certificate ▪ P6: Certificate of Marking Transfer and Raw Material Certificates ▪ PM: Positive Material Identification of wetted parts

Model code position	Model code	Description
15	/P12	Combination of: <ul style="list-style-type: none"> ▪ P3: Quality Inspection Certificate ▪ P6: Certificate of Marking Transfer and Raw Material Certificates ▪ PT: Dye penetrant test according to DIN EN ISO 3452-1 ▪ P8: Hydrostatic Pressure Test Certificate
15	/P13	Combination of: <ul style="list-style-type: none"> ▪ P3: Quality Inspection Certificate ▪ P6: Certificate of Marking Transfer and Raw Material Certificates ▪ PT: Dye penetrant test according to DIN EN ISO 3452-1 ▪ PM: Positive Material Identification of wetted parts ▪ P8: Hydrostatic Pressure Test Certificate ▪ WP: Welding certificates
15	/P14	Combination of: <ul style="list-style-type: none"> ▪ PM: Positive Material Identification of wetted parts ▪ P8: Hydrostatic Pressure Test Certificate ▪ WP: Welding certificates
15	/P20	Combination of: <ul style="list-style-type: none"> ▪ PTA: Dye penetrant test of flange welding according ASME V ▪ WPA: Welding procedures and Certificates according ASME IX ▪ RTA: X-ray test according ASME V
15	/P21	Combination of: <ul style="list-style-type: none"> ▪ P3: Quality Inspection Certificate ▪ P6: Certificate of Marking Transfer and Raw Material Certificates ▪ P8: Hydrostatic Pressure Test Certificate ▪ PTA: Dye penetrant test of flange welding according ASME V ▪ WPA: Welding procedures and Certificates according ASME IX ▪ RTA: X-ray test according ASME V
15	/P22	Combination of: <ul style="list-style-type: none"> ▪ P3: Quality Inspection Certificate ▪ P6: Certificate of Marking Transfer and Raw Material Certificates ▪ PM: Positive Material Identification of wetted parts ▪ PTA: Dye penetrant test of flange welding according ASME V ▪ WPA: Welding procedures and Certificates according ASME IX ▪ RTA: X-ray test according ASME V
Tube Health Check		
15	/TC	Tube Health Check
Batching function		
15	/BT	Batching and filling function
Transmitter housing rotated 180°		
15	/RB	Alignment of transmitter housing rotated 180°
Viscosity function		
15	/VM	Viscosity computing function for liquids
Custody transfer measurement		
15	/Q20	NTEP approval, accuracy class 0.3 acc. NIST Handbook 44
15	/EPT	Expanded process fluid temperature range for temperatur classes T6, T5, T4 and T3 for hazardous areas

Model code position	Model code	Description
Measurement of heat quantity		
15	/CGC	Measurement of the total transported energy content of a fuel in connection with a sensor for determining the fuel's calorific value (e.g., a gas chromatograph, not included in scope of delivery).
Marine Approval		
15	/MC2	Marine approval according DNV, EU RO MR TAC, ABS and KR piping class 2
15	/MC3	Marine approval according DNV, EU RO MR TAC, ABS and KR piping class 3
15	/MC4	Marine approval according LR MR TAC piping class 2
15	/MC5	Marine approval according LR MR TAC piping class 3
Connecting cable type and length		
15	/L000	Without standard connecting cable
15	/L005	5 meter (16.4 ft) remote connecting cable terminated; standard gray / Ex blue
15	/L010	10 meter (32.8 ft) remote connecting cable terminated; standard gray / Ex blue
15	/L015	15 meter (49.2 ft) remote connecting cable terminated; standard gray / Ex blue
15	/L020	20 meter (65.6 ft) remote connecting cable terminated; standard gray / Ex blue
15	/L030	30 meter (98.4 ft) remote connecting cable terminated; standard gray / Ex blue
15	/Y000	Without fire retardant connecting cable
15	/Y005	5 meter (16.4 ft) remote fire retardant connecting cable, not terminated, with DNV Type Approval Certificate
15	/Y010	10 meter (32.8 ft) remote fire retardant connecting cable, not terminated, with DNV Type Approval Certificate
15	/Y015	15 meter (49.2 ft) remote fire retardant connecting cable, not terminated, with DNV Type Approval Certificate
15	/Y020	20 meter (65.6 ft) remote fire retardant connecting cable, not terminated, with DNV Type Approval Certificate
15	/Y030	30 meter (98.4 ft) remote fire retardant connecting cable, not terminated, with DNV Type Approval Certificate
Cable glands and blind plug		
15	/V52	2 cable glands, 1 blind plug for power, communication and I/O
15	/V53	3 cable glands for power, communication and I/O
15	/NL	NAMUR installation length according to NE132
15	/CL	Customer-specific installation length
15	/BN	Stainless steel nameplate for sensor
Customized installation length		
15	/NL	NAMUR installation length according to NE132
15	/CL	Customer-specific installation length
Adapter for cable entries		
15	/AD2	2 adapter ANSI 1/2 in. NPT to JIS G1/2
Steel armored connecting cable		
15	/LAC	Steel armored version of standard connecting cable

Not all options are available in all countries. For details please contact your local Yokogawa Sales Organization.

8.2 Available model codes per basic model



For complete product configuration, please refer to the FlowConfigurator online sizing and configuration tool: <http://www.FlowConfigurator.com>

Stainless Steel Devices															
Code	Essential Transmitter					Ultimate Transmitter					Spare Sensor				
	RCEP25S	RCEP40S	RCEP50S	RCEP80S	RCEP1HS	RCUP25S	RCUP40S	RCUP50S	RCUP80S	RCUP1HS	RCNP25S	RCNP40S	RCNP50S	RCNP80S	RCNP1HS
process connection size															
-08	•					•					•				
-15	•	•				•	•				•	•			
-20	•	•				•	•				•	•			
-25	•	•	•			•	•	•			•	•	•		
-40	•	•	•	•		•	•	•	•		•	•	•	•	
-50			•	•				•	•				•	•	
-65				•					•					•	
-80				•	•				•					•	•
-1H					•					•					•
-1Q					•					•					•
process connection type															
TT9	•	•				•	•				•	•			
TG9	•	•				•	•				•	•			
BJ2	•	•	•	•	•	•	•	•	•	•	•	•	•	•	•
CA4	•	•	•	•	•	•	•	•	•	•	•	•	•	•	•
ED6	•	•	•	•	•	•	•	•	•	•	•	•	•	•	•
FD6	•	•	•	•	•	•	•	•	•	•	•	•	•	•	•
GD4	•	•	•	•	•	•	•	•	•	•	•	•	•	•	•
GD6	•	•	•	•	•	•	•	•	•	•	•	•	•	•	•
BA1	•	•	•	•	•	•	•	•	•	•	•	•	•	•	•
BA2	•	•	•	•	•	•	•	•	•	•	•	•	•	•	•
BA4	•	•	•	•	•	•	•	•	•	•	•	•	•	•	•
BD4	•	•	•	•	•	•	•	•	•	•	•	•	•	•	•
BD6	•	•	•	•	•	•	•	•	•	•	•	•	•	•	•
BJ1	•	•	•	•	•	•	•	•	•	•	•	•	•	•	•
BP1	•	•	•	•	•	•	•	•	•	•	•	•	•	•	•
BP2	•	•	•	•	•	•	•	•	•	•	•	•	•	•	•
BP4	•	•	•	•	•	•	•	•	•	•	•	•	•	•	•
ED4	•	•	•	•	•	•	•	•	•	•	•	•	•	•	•
FD4	•	•	•	•	•	•	•	•	•	•	•	•	•	•	•
Sensor housing material															
0	•	•	•	•	•	•	•	•	•	•	•	•	•	•	•
Process fluid temperature range															
0	•	•	•	•	•	•	•	•	•	•	•	•	•	•	•
Mass flow and density accuracy															
E7	•	•	•	•	•	•	•	•	•	•					
E3						•	•	•	•	•					
E2						•	•	•	•	•					
D7						•	•	•	•	•					
D3						•	•	•	•	•					
D2						•	•	•	•	•					
C7						•	•	•	•	•	•	•	•	•	•
C3						•	•	•	•	•					•
C2						•	•	•	•	•	•	•	•	•	•
70	•	•	•	•	•										
50						•	•	•	•	•					
30						•	•	•	•	•	•	•	•	•	•
Design and housing															
0	•	•	•	•	•	•	•	•	•	•	•	•	•	•	•
2	•	•	•	•	•	•	•	•	•	•	•	•	•	•	•
A	•	•	•	•	•	•	•	•	•	•	•	•	•	•	•
E	•	•	•	•	•	•	•	•	•	•	•	•	•	•	•
J	•	•	•	•	•	•	•	•	•	•	•	•	•	•	•

Stainless Steel Devices															
Code	Essential Transmitter					Ultimate Transmitter					Spare Sensor				
	RCEP25S	RCEP40S	RCEP50S	RCEP80S	RCEP1HS	RCUP25S	RCUP40S	RCUP50S	RCUP80S	RCUP1HS	RCNP25S	RCNP40S	RCNP50S	RCNP80S	RCNP1HS
Ex Approvals															
-NN00	•	•	•	•	•	•	•	•	•	•	•	•	•	•	•
-KF21	•	•	•	•	•	•	•	•	•	•	•	•	•	•	•
-KF22	•	•	•	•	•	•	•	•	•	•	•	•	•	•	•
-BF21	•	•	•	•	•	•	•	•	•	•	•	•	•	•	•
-BF22	•	•	•	•	•	•	•	•	•	•	•	•	•	•	•
-FF11	•	•	•	•	•	•	•	•	•	•	•	•	•	•	•
-FF12	•	•	•	•	•	•	•	•	•	•	•	•	•	•	•
-SF21	•	•	•	•	•	•	•	•	•	•	•	•	•	•	•
-SF22	•	•	•	•	•	•	•	•	•	•	•	•	•	•	•
-GF21	•	•	•	•	•	•	•	•	•	•	•	•	•	•	•
-GF22	•	•	•	•	•	•	•	•	•	•	•	•	•	•	•
-UF21	•	•	•	•	•	•	•	•	•	•	•	•	•	•	•
-UF22	•	•	•	•	•	•	•	•	•	•	•	•	•	•	•
-NF21	•	•	•	•	•	•	•	•	•	•	•	•	•	•	•
-NF22	•	•	•	•	•	•	•	•	•	•	•	•	•	•	•
-JF53	•	•	•	•	•	•	•	•	•	•					
-JF54	•	•	•	•	•	•	•	•	•	•					
-PF21	•	•	•	•	•	•	•	•	•	•	•	•	•	•	•
-PF22	•	•	•	•	•	•	•	•	•	•	•	•	•	•	•
Cable entries															
-2	•	•	•	•	•	•	•	•	•	•	•	•	•	•	•
-4	•	•	•	•	•	•	•	•	•	•	•	•	•	•	•
Communication type and I/O															
-JA	•	•	•	•	•	•	•	•	•	•	•	•	•	•	•
-JB	•	•	•	•	•	•	•	•	•	•	•	•	•	•	•
-JC	•	•	•	•	•	•	•	•	•	•	•	•	•	•	•
-JD	•	•	•	•	•	•	•	•	•	•	•	•	•	•	•
-JE	•	•	•	•	•	•	•	•	•	•	•	•	•	•	•
-JF	•	•	•	•	•	•	•	•	•	•	•	•	•	•	•
-JG	•	•	•	•	•	•	•	•	•	•	•	•	•	•	•
-JH						•	•	•	•	•	•	•	•	•	•
-JJ						•	•	•	•	•	•	•	•	•	•
-JK						•	•	•	•	•	•	•	•	•	•
-JL						•	•	•	•	•	•	•	•	•	•
-JM						•	•	•	•	•	•	•	•	•	•
-JN						•	•	•	•	•	•	•	•	•	•
-JP	•	•	•	•	•	•	•	•	•	•	•	•	•	•	•
-JQ	•	•	•	•	•	•	•	•	•	•	•	•	•	•	•
-JR	•	•	•	•	•	•	•	•	•	•	•	•	•	•	•
-JS	•	•	•	•	•	•	•	•	•	•	•	•	•	•	•
-F0						•	•	•	•	•	•	•	•	•	•
-F1						•	•	•	•	•	•	•	•	•	•
-G0						•	•	•	•	•	•	•	•	•	•
-G1						•	•	•	•	•	•	•	•	•	•
-M0	•	•	•	•	•	•	•	•	•	•	•	•	•	•	•
-M2						•	•	•	•	•	•	•	•	•	•
-M3	•	•	•	•	•	•	•	•	•	•	•	•	•	•	•
-M4	•	•	•	•	•	•	•	•	•	•	•	•	•	•	•
-M5	•	•	•	•	•	•	•	•	•	•	•	•	•	•	•
-M6	•	•	•	•	•	•	•	•	•	•	•	•	•	•	•
-M7						•	•	•	•	•	•	•	•	•	•
-NN											•	•	•	•	•
Display															
0	•	•	•	•	•										
1	•	•	•	•	•	•	•	•	•	•					
N											•	•	•	•	•
Additional nameplate information															
/BG	•	•	•	•	•	•	•	•	•	•	•	•	•	•	•
Pre-setting of customer parameters															
/PS	•	•	•	•	•	•	•	•	•	•					

Stainless Steel Devices															
Code	Essential Transmitter					Ultimate Transmitter					Spare Sensor				
	RCEP25S	RCEP40S	RCEP50S	RCEP80S	RCEP1HS	RCUP25S	RCUP40S	RCUP50S	RCUP80S	RCUP1HS	RCNP25S	RCNP40S	RCNP50S	RCNP80S	RCNP1HS
Country-specific delivery															
/PJ	•	•	•	•	•	•	•	•	•	•	•	•	•	•	•
/CN	•	•	•	•	•	•	•	•	•	•	•	•	•	•	•
/KC	•	•	•	•	•	•	•	•	•	•	•	•	•	•	•
/VB	•	•	•	•		•	•	•	•						
/VE	•	•	•	•	•	•	•	•	•	•	•	•	•	•	•
/VR	•	•	•	•	•	•	•	•	•	•	•	•	•	•	•
/UK	•	•	•	•	•	•	•	•	•	•	•	•	•	•	•
Country-specific application															
/Q11	•	•	•	•	•	•	•	•	•	•	•	•	•	•	•
/QR2	•	•	•	•	•	•	•	•	•	•	•	•	•	•	•
/QR3	•	•	•	•	•	•	•	•	•	•	•	•	•	•	•
TS1	•	•	•	•	•	•	•	•	•	•	•	•	•	•	•
TS2	•	•	•	•	•	•	•	•	•	•	•	•	•	•	•
/CS	•	•	•	•	•	•	•	•	•	•	•	•	•	•	•
Concentration and Petroleum measurement															
/CST						•	•	•	•	•					
/AC0						•	•	•	•	•					
/AC1						•	•	•	•	•					
/AC4						•	•	•	•	•					
/C52						•	•	•	•	•					
Customer-specific calibration															
/K2	•	•	•	•	•	•	•	•	•	•					
/K5	•	•	•	•	•	•	•	•	•	•					
Accordance with terms of order															
/P2	•	•	•	•	•	•	•	•	•	•	•	•	•	•	•
/P3	•	•	•	•	•	•	•	•	•	•	•	•	•	•	•
Material certificates															
/P6	•	•	•	•	•	•	•	•	•	•	•	•	•	•	•
Pressure testing															
/P8	•	•	•	•	•	•	•	•	•	•	•	•	•	•	•
Surfaces free of oil and grease															
/H1	•	•	•	•	•	•	•	•	•	•	•	•	•	•	•
Welding certificate															
/WP	•	•	•	•	•	•	•	•	•	•	•	•	•	•	•
/WPA	•	•	•	•	•	•	•	•	•	•	•	•	•	•	•
Calibration certificate															
/L2	•	•	•	•	•	•	•	•	•	•					
/L3	•	•	•	•	•	•	•	•	•	•					
/L4	•	•	•	•	•	•	•	•	•	•					
ASME B31.3 compliance															
/P15	•	•	•	•	•	•	•	•	•	•	•	•	•	•	•
X-ray inspection of flange weld seam															
/RT	•	•	•	•	•	•	•	•	•	•	•	•	•	•	•
/RTA	•	•	•	•	•	•	•	•	•	•	•	•	•	•	•
Positive Material Identification of wetted parts															
/PM	•	•	•	•	•	•	•	•	•	•	•	•	•	•	•
Dye penetrant test of weld seams															
/PT	•	•	•	•	•	•	•	•	•	•	•	•	•	•	•
/PTA	•	•	•	•	•	•	•	•	•	•	•	•	•	•	•
Combined certificate															
/P10	•	•	•	•	•	•	•	•	•	•	•	•	•	•	•
/P11	•	•	•	•	•	•	•	•	•	•	•	•	•	•	•
/P12	•	•	•	•	•	•	•	•	•	•	•	•	•	•	•
/P13	•	•	•	•	•	•	•	•	•	•	•	•	•	•	•
/P14	•	•	•	•	•	•	•	•	•	•	•	•	•	•	•
/P20	•	•	•	•	•	•	•	•	•	•	•	•	•	•	•
/P21	•	•	•	•	•	•	•	•	•	•	•	•	•	•	•
/P22	•	•	•	•	•	•	•	•	•	•	•	•	•	•	•
Tube Health Check															
/TC	•	•	•	•	•	•	•	•	•	•					
Batching function															
/BT						•	•	•	•	•					

Stainless Steel Devices															
Code	Essential Transmitter					Ultimate Transmitter					Spare Sensor				
	RCEP25S	RCEP40S	RCEP50S	RCEP80S	RCEP1HS	RCUP25S	RCUP40S	RCUP50S	RCUP80S	RCUP1HS	RCNP25S	RCNP40S	RCNP50S	RCNP80S	RCNP1HS
Transmitter housing rotated 180°															
/RB	•	•	•	•	•	•	•	•	•	•					
Viscosity function															
/VM						•	•	•	•	•					
Custody transfer measurement															
/Q20						•	•	•	•	•					
Enhanced process temperature (Ex)															
/EPT	•	•	•			•	•	•			•	•	•		
Measurement of heat quantity															
/CGC						•	•	•	•	•					
Marine Approval															
/MC2	•	•	•	•	•	•	•	•	•	•					
/MC3	•	•	•	•	•	•	•	•	•	•					
/MC4	•	•	•	•	•	•	•	•	•	•					
/MC5	•	•	•	•	•	•	•	•	•	•					
Connecting cable type and length															
/L000	•	•	•	•	•	•	•	•	•	•	•	•	•	•	•
/L005	•	•	•	•	•	•	•	•	•	•					
/L010	•	•	•	•	•	•	•	•	•	•					
/L015	•	•	•	•	•	•	•	•	•	•					
/L020	•	•	•	•	•	•	•	•	•	•					
/L030	•	•	•	•	•	•	•	•	•	•					
/Y000	•	•	•	•	•	•	•	•	•	•	•	•	•	•	•
/Y005	•	•	•	•	•	•	•	•	•	•					
/Y010	•	•	•	•	•	•	•	•	•	•					
/Y015	•	•	•	•	•	•	•	•	•	•					
/Y020	•	•	•	•	•	•	•	•	•	•					
/Y030	•	•	•	•	•	•	•	•	•	•					
Cable glands and blind plug															
/V52	•	•	•	•	•	•	•	•	•	•					
/V53	•	•	•	•	•	•	•	•	•	•					
Customized installation length															
/NL	•	•	•	•	•	•	•	•	•	•	•	•	•	•	•
/CL	•	•	•	•	•	•	•	•	•	•	•	•	•	•	•
Stainless steel nameplate for sensor															
/BN	•	•	•	•	•	•	•	•	•	•	•	•	•	•	•
Adapter for cable entries															
/AD2	•	•	•	•	•	•	•	•	•	•					
Steel armored connecting cable															
/LAC	•	•	•	•	•	•	•	•	•	•					

8.3 Model code combinations



For complete product configuration, please refer to the FlowConfigurator online sizing and configuration tool: <http://www.FlowConfigurator.com>

AGA11 Declaration of Conformity

A certificate about AGA11 declaration of conformity will be issued with the following configuration.

RC

1	2	3	4	5	6	7	8	9	10	11	12	13	14	15					

 -

5	6	7	8	9	10	11	12	13	14	15									

 -

8	9	10	11	12	13	14	15												

 -

11	12	13	14	15															

 -

13	14																		

 /

15																			

 / K5/TC

Model code position	Code	Description
9	30, 50 or 70	Mass flow accuracy for gases
13	J_	HART Interface
15	/K5	Option Customer-specific 10-point mass flow calibration
	/TC	Option Tube Health Check



Please note: AGA11 declaration of conformity available with Rotamass Total Insight HART firmware rev.4 or later. For details please contact your local Yokogawa sales organization.

8.4 Ordering Instructions

Specify the following information when ordering a product:

8.4.1 Mandatory ordering instructions

The following information have to be specified when ordering a product:

- Model code
- Fluid name
- Rotamass TI is delivered with quick reference hardcopy, a compressed version of the general instruction manual. For delivery choose one of the languages below:
 - English
 - French
 - German
 - Japanese
 - Chinese
 - Korean
 - Russian

8.4.2 Optional ordering instructions

The following information depend on the product configuration and can or have to be selected.

Manual and display language

- Display language and units depend on the selected language pack:

pack 1	pack 2	pack 3
EN-Pack1 - English	EN-Pack2 - English	EN-Pack3 - English
DE-Pack1 - German	DE-Pack2 - German	DE-Pack3 - German
FR-Pack1 - French	RU-Pack2 - Russian	FR-Pack3 - French
PT-Pack1 - Portuguese	PL-Pack2 - Polish	PT-Pack3 - Portuguese
IT-Pack1 - Italian	KZ-Pack2 - Kazakh	IT-Pack3 - Italian
ES-Pack1 - Spanish		ES-Pack3 - Spanish
JA-Pack1 - Japanese		CN-Pack3 - Chinese

- Unit notation on the display (display only present for value 1 on position 14 of the model code):
 - Metric units
 - Imperial units - US
 - Imperial units - GB
 - Russia specific units (only available with language pack 2)
 - Japan specific units (only available with language pack 1)

Display orientation

- When display is ordered, its orientation has to be specified.

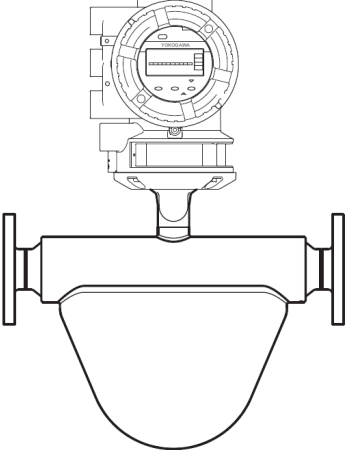
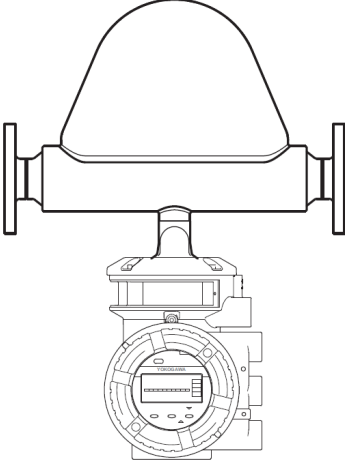
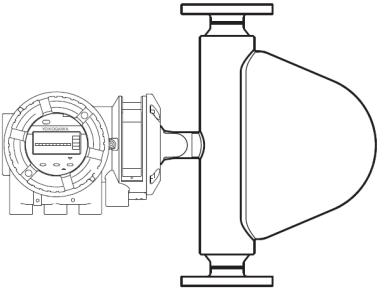
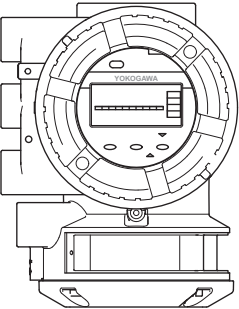
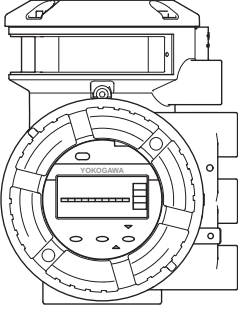
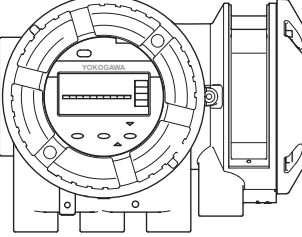
	Orientation 1	Orientation 2	Orientation 3
Integral type	<p>Horizontal installation - tubes down</p> 	<p>Horizontal installation - tubes up</p> 	<p>Vertical installation</p> 
Remote type			



In the above the figure, the housing of the Prime sensor is shown. The design of sensor depends on the chosen series.



The parameter "Installation Orientation" in transmitter must be set by the customer according to the installation direction of the sensor.

Serial and tag number, customer name

- Tag No. engraved on the nameplate and mentioned on the calibration certificate (option BG, up to 17 characters length)
- Software Tag No.: short and long (short tag no. mentioned also on the calibration certificate):

Parameter	Value
HART Tag No. (short): up to 8 characters length (Capital letters only)	Default value has 8 space characters
HART Tag No. (long): up to 32 characters length	Default value has 32 space characters
PROFIBUS PA NODE ADDRESS (HEX): up to 2 characters length	Default value '0x7E' unless otherwise specified
PROFIBUS PA SOFTWARE TAG: up to 32 characters length	Default value 'FT2001' unless otherwise specified
FOUNDATION Fieldbus NODE ADDRESS (HEX): up to 2 characters length	Default value '0xF6' unless otherwise specified
FOUNDATION Fieldbus SOFTWARE TAG: up to 32 characters length	Default value 'FT2004' unless otherwise specified

Specify the following information when ordering option /SNC for a Spare Transmitter RCUXNNN:

- Serial number of the transmitter to be replaced.
- Customer name for the certificates (option L2, L3, L4: up to 40 characters length)

Concentration measurement

In case advanced concentration measurement with predefined sets (option AC1, AC4) is ordered, at least one of the following sets have to be selected:

- C01 Sugar / Water 0 – 85 °Bx, 0 – 80 °C
- C02 NaOH / Water 2 – 50 WT%, 0 – 100 °C
- C03 KOH / Water 0 – 60 WT%, 54 – 100 °C
- C04 NH₄NO₃ / Water 1 – 50 WT%, 0 – 80 °C
- C05 NH₄NO₃ / Water 20 – 70 WT%, 20 – 100 °C
- C06 HCl / Water 22 – 34 WT%, 20 – 40 °C
- C07 HNO₃ / Water 50 – 67 WT%, 10 – 60 °C
- C09 H₂O₂ / Water 30 – 75 WT%, 4 – 44 °C
- C10 Ethylene Glycol / Water 10 – 50 WT%, -20 – 40 °C
- C11 Amylum = starch / Water 33 – 43 WT%, 35 – 45 °C
- C12 Methanol / Water 35 – 60 WT%, 0 – 40 °C
- C20 Alcohol / Water 55 – 100 VOL%, 10 – 40 °C
- C21 Sugar / Water 40 – 80 °Bx, 75 – 100 °C
- C30 Alcohol / Water 66 – 100 WT%, 15 – 40 °C
- C37 Alcohol / Water 66 – 100 WT%, 10 – 40 °C

TRADEMARKS

HART:	registered trademark of FieldComm Group, Inc., US
Modbus:	registered trademark of SCHNEIDER ELECTRIC USA, INC.
PROFIBUS:	registered trademark of PROFIBUS Nutzerorganisation e.V., Karlsruhe, DE
FOUNDATION Fieldbus:	registered trademark of FieldComm Group, Inc., US
ROTAMASS:	registered trademark of Rota Yokogawa GmbH & Co. KG, DE
FieldMate:	registered trademark of YOKOGAWA ELECTRIC CORPORATION
SD:	registered trademark of SD-3C LLC.
QR code:	registered trademark of DENSO WAVE INCORPORATED

All other company and product names mentioned in this document are trade names, trademarks or registered trademarks of their respective companies. In this document, trademarks or registered trademarks are not marked with TM or ®.

All rights reserved. Copyright © 2024-08-07

Manufacturer:

Rota Yokogawa GmbH & Co. KG
Rheinstr. 8
D-79664 Wehr
Germany

For the actual manufacturing location of your device refer to the model code and/or serial number.

**COMPANY WITH
QUALITY SYSTEM
CERTIFIED BY DNV GL
= ISO 9001 =**