

Konformitäts- erklärung	Declaration of conformity	Déclaration de conformité	Dichiarazione di conformità
Gebrauchs- anleitung	Instructions	Notice d'utilisation	Istruzioni di esercizio e di montaggio
LGW...A4, LGW...A4/2 LGW... / ...A4			
Differenzdruck- wächter für Luft, Rauch- und Ab- gase, Überdruck- wächter für Gas Doppeldruck- wächter	Differential pres- sure switch for air, flue and exhaust gases, pressure switch for gas Double pressure switch	Pressostat dif- férentiel pour air, fumée et gaz brûlés, Contrôleur de surpression pour gaz Pressostat double	Pressostato diffe- renziale per aria, gas di combusti- one e di scarico, pressostati di sovrapressione per gas Pressostato doppio

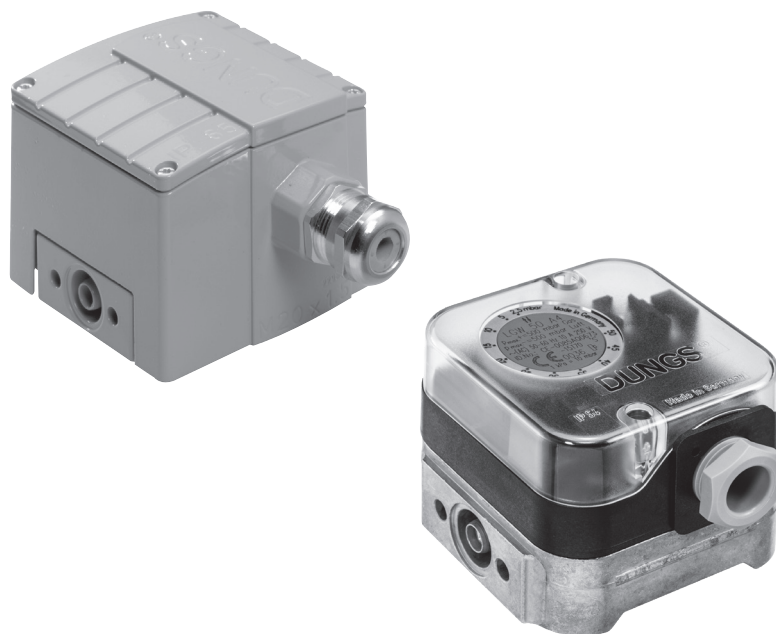

LGW...A4, LGW...A4/2
LGW... / ...A4
223 906



EU-Konformitäts- erklärung	EU Declaration of conformity	Déclaration de conformité UE	Dichiarazione di conformità UE
---------------------------------------	---	---	---

Produkt / Product Produit / Prodotto	LGW...A4, LGW...A4/2 LGW... / ...A4	Differenzdruckwächter für Luft, Rauch- und Abgase, Überdruckwächter für Gas / Differential pressure switch for air, flue and exhaust gases, pressure switch for gas / Pressostat différentiel pour air, fumée et gaz brûlés, Contrôleur de surpression pour gaz / Pressostato differenziale per aria, gas di combustione e di scarico, pressostati di sovrappressione per gas Doppeldruckwächter / Double pressure switch Pressostat double / Pressostato doppio	
Hersteller / Manufacturer Fabricant / Produttore	Karl Dungs GmbH & Co. KG · Karl-Dungs-Platz 1 · D-73660 Urbach/Germany		
<p>bescheinigt hiermit, dass die in dieser Übersicht genannten Produkte einer EU-Baumusterprüfung (Baumuster) unterzogen wurden und die wesentlichen Sicherheitsanforderungen der:</p> <ul style="list-style-type: none"> • EU-Gasgeräteverordnung (EU) 2016/426 • EU-Druckgeräterichtlinie 2014/68/EU • Niederspannungsrichtlinie 2014/35/EU <p>in der gültigen Fassung erfüllen.</p> <p>Alle nach Druckgeräterichtlinie zugelassenen Komponenten sind Ausrüstungsteile mit Sicherheitsfunktion. Bei einer von uns nicht freigegebenen Änderung des Gerätes verliert diese Erklärung ihre Gültigkeit. Der oben beschriebene Gegenstand der Erklärung entspricht den einschlägigen Harmonisierungsvorschriften der Union. Die alleinige Verantwortung für die Ausstellung dieser Konformitätserklärung trägt der Hersteller.</p>	<p>certifies herewith that the products named in this overview were subjected to an EU-Type Examination (production type) and meet the essential safety requirements:</p> <ul style="list-style-type: none"> • EU-Gas Appliances Regulation (EU) 2016/426 • EU-Pressure Equipment Directive "2014/68/EU" • Low-Voltage Directive "2014/35/EU" <p>as amended.</p> <p>All of the components certified according to the Pressure Equipment Directive are equipment parts with safety function. In the event of an alteration of the equipment not approved by us this declaration loses its validity. The object of the declaration described above conforms with the relevant Union harmonisation legislation. This declaration of conformity is issued under the sole responsibility of the manufacturer.</p>	<p>certifie par la présente que le produit mentionné dans cette vue d'ensemble a été soumis à un examen UE de type (type de fabrication) et qu'il est conforme aux exigences en matières de sécurité des dernières versions en vigueur de :</p> <ul style="list-style-type: none"> • Règlement européen sur les appareils brûlant des combustibles gazeux (UE) 2016/426 • Directive européenne relative aux appareils sous pression 2014/68/UE • Directive basse tension 2014/35/UE <p>Tous les composants homologués conformément à la directive sur les dispositifs sous pression sont des éléments d'équipement à fonction de sécurité. Ce communiqué n'est plus valable si nous effectuons une modification libre de l'appareil. L'objet décrit ci-dessus de la présente déclaration correspond aux prescriptions légales applicables en matière d'harmonisation de l'Union. Le fabricant porte l'entière responsabilité pour l'établissement de la présente déclaration de conformité.</p>	<p>Con la presente si certifica che i prodotti citati in questa panoramica sono stati sottoposti a una prova di esame UE del tipo (tipo di produzione) e che i requisiti di sicurezza essenziali:</p> <ul style="list-style-type: none"> • Regolamento UE sugli apparecchi a gas (UE) 2016/426 • Direttiva UE sulle attrezzature a pressione 2014/68/UE • Direttiva sulla bassa tensione 2014/35/UE <p>sono soddisfatti nella versione valida.</p> <p>Tutti i componenti approvati secondo la direttiva sulle apparecchiature a pressione sono parti di apparecchiature con funzione di sicurezza. In caso di modifica dell'apparecchio non ammessa, questa dichiarazione perde di validità. L'oggetto della dichiarazione di cui sopra descritta è conforme alla pertinente normativa di armonizzazione dell'Unione. La presente dichiarazione di conformità è rilasciata sotto la responsabilità esclusiva del fabbricante.</p>
Prüfgrundlage der EU-Baumusterprüfung (Baumuster) Specified requirements of the EU-Type Examination (production type) Base d'essai de l'examen UE de type (type de fabrication) Criteri di prova dell'omologazione esame UE del tipo (tipo di produzione)	EN 1854 EN 13611 ISO 23550		
Gültigkeitsdauer / Bescheinigung Term of validity / attestation Validité / certificat Durata della validità / Attestazione	2033-08-02 CE0036	2028-02-27 CE-0123CT1078	
Notifizierte Stelle Notified Body Organisme notifié Organismo notificato	2014/68/EU TÜV SÜD Industrie Service GmbH Westendstraße 199 D-80686 München, Germany Notified Body number: 0036	(EU) 2016/426 TÜV SÜD Product Service GmbH Zertifizierstellen Ridlerstraße 65 D-80339 München, Germany Notified Body number: 0123	
Überwachung des QS-Systems Monitoring of the QA system Contrôle du système d'assurance qualité Monitoraggio del sistema QS	Gewähltes Konformitätsverfahren Modul B+D Conformity process adopted: Module B+D Procédure de conformité sélectionnée : module B+D Procedura di conformità selezionata: modulo B+D		
B.Sc., MBA Simon P. Dungs, Geschäftsführer / Chief Operating Officer / Directeur / Amministratore Urbach, 2023-12-05			

Declaration of Conformity

Product	LGW...A4, LGW...A4/2 LGW... / ...A4	Differential pressure switch for air, flue and exhaust gases, pressure switch for gas Double pressure switch	
Manufacturer	Karl Dungs GmbH & Co. KG · Karl-Dungs-Platz 1 · D-73660 Urbach/Germany		
<p>Certifies herewith that the products named in this overview were subjected to a Type Examination (production type) and meet the essential safety requirements:</p> <ul style="list-style-type: none"> • Gas Appliances (Enforcement) and Miscellaneous Amendment Regulations, UKSI 2018:389 (as amended by UKSI 2019:696) • The Pressure Equipment Safety Regulations, UKSI 2016:1105 (as amended by UKSI 2019: 969) • The Electrical Equipment (Safety) Regulations 2016, UKSI 2016: 1101 as amended <p>All of the components certified according to the Pressure Equipment (Safety) Regulations 2016 are equipment parts with safety function. In the event of an alteration of the equipment not approved by us this declaration loses its validity. The object of the declaration described above conforms with the relevant legislation. This declaration of conformity is issued under the sole responsibility of the manufacturer.</p>			
Specified requirements of the Type Examination (production type)	EN 1854 EN 13611		
Term of validity	2032-08-07	2032-08-11	
Approved Bodies	2016 No. 1105 TUV SUD BABT Unlimited Octagon House, Concorde Way, Segensworth North, Fareham, Hampshire, PO15 5RL, United Kingdom Approved Body Number: 0168	2018 No. 389 TUV SUD BABT Unlimited Octagon House, Concorde Way, Segensworth North, Fareham, Hampshire, PO15 5RL, United Kingdom Approved Body Number: 0168	
Monitoring of the QA system	Conformity process adopted: Module B+D		
B.Sc., MBA Simon P. Dungs, Chief Operating Officer Urbach, 2022-08-29			



Betriebs- und Montageanleitung

Differenzdruckwächter für Luft, Rauch- und Abgase, Überdruckwächter für Gas
LGW...A4, LGW...A4/2
Doppeldruckwächter
LGW... / ...A4

Operation and assembly instructions

Differential pressure switch for air, flue and exhaust gases, pressure switch for gas
LGW...A4, LGW...A4/2
Double pressure switch
LGW... / ...A4

Notice d'emploi et de montage

Pressostat différentiel pour air, fumée et gaz brûlés, Contrôleur de surpression pour gaz
LGW...A4, LGW...A4/2
Pressostat double
LGW... / ...A4

Istruzioni di esercizio di montaggio

Pressostato differenziale per aria, gas di combustione e di scarico, pressostati di sovrappressione per gas
LGW...A4, LGW...A4/2
Pressostato doppio
LGW... / ...A4



Max. Betriebsdruck
Max. operating pressure
Pression de service maxi.
Max. pressione di esercizio
 $p_{max.} = 500 \text{ mbar (50 kPa)}$

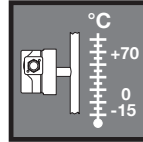

Umgebungstemperatur
Ambient temperature
Température ambiante
Temperatura ambiente
-15 °C ... +70 °C

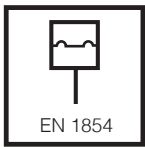

Druckwächter/ Pressure Switch/
Pressostat/ Pressostato
Typ/Type/Type/Tipo
LGW...A4, LGW...A4/2
nach / acc. / selon / a norme
EN 1854

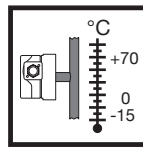

Mediumtemperatur
Medium temperature
Température du fluide
Temperatura fluido
-15 °C ... +70 °C

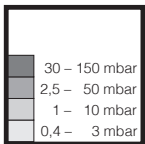

Einstellbereiche
Setting ranges
Plages de réglage
Campi di taratura

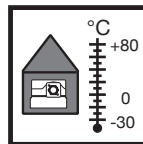

Lagertemperatur
Storage temperature
Température de stockage
Temperatura stoccaggio
-30 °C ... +80 °C

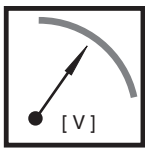

Ag-Kontakt/Ag contact
Contact Ag/Contatti Ag
~(AC) eff., min./mini 24 V,
~(AC) max./maxi. 250 V
=(DC) min./mini. 24 V,
=(DC) max./maxi. 48 V
Au-Kontakt/Au contact
Contact Au/Contatti Au
=(DC) min./mini. 5 V,
=(DC) max./maxi. 24 V



Schutzart / Degree of protection
Protection / Protezione
LGW... A4
IP 54 nach / acc. / selon / a norme
IEC 529 (EN 60529)
LGW... A4/2
IP 65 nach / acc. / selon / a norme
IEC 529 (EN 60529)



Nennstrom/nominal current/courant nominal/corrente nominale
~(AC) 10 A
Schaltstrom/current on contact/courant de commutation/corrente di intervento
~(AC) eff., min./mini 20 mA,
~(AC) max./maxi. 6 A $\cos \varphi 1$
~(AC) max./maxi. 3 A $\cos \varphi 0,6$
=(DC) min./mini. 20 mA
=(DC) max./maxi. 1 A

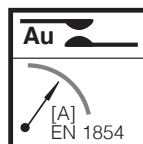

Nennstrom/nominal current/courant nominal/corrente nominale
= (DC) 20 mA
Schaltstrom/current on contact/courant de commutation/corrente di intervento
=(DC) min./mini. 5 mA
=(DC) max./maxi. 20 mA

Einbau- / Installation position / Position de montage / Posizione de montaggio

	Standardeinbau- Standard installation position Position de montage standard Posizione standard
	Bei waagrechtem Einbau schaltet der Druckwächter bei einem um ca. 0,5 mbar höheren Druck. In the horizontal installation position the switching pressure is increased by approx. 0.5 mbar. Monté horizontalement, le pressostat commute à une pression d'environ 0,5 mbar plus élevée. Con montaggio orizzontale il pressostato scatta ad pressione superiore di circa 0,5 mbar.
	Bei Einbau waagrecht über Kopf schaltet der Druckwächter bei einem um ca. 0,5 mbar niedrigeren Druck. When the pressure switch is mounted horizontally overhead, its switching pressure decreases by approx. 0.5 mbar. Monté horizontalement à l'envers, le pressostat commute à une pression d'environ 0,5 mbar moins élevée. Con montaggio orizzontale capovolto il pressostato scatta ad una pressione inferiore di circa 0,5 mbar.
	Bei Einbau in einer Zwischeneinbau- When the pressure switch is mounted in an intermediate position, its switching pressure deviates by max. ± 0.5 mbar from the setpoint. Monté dans une position intermédiaire, le pressostat commute à une pression d'un maximum de ± 0,5 mbar par rapport à la valeur de consigne réglée. Con il montaggio in una posizione intermedia il pressostato scatta ad una pressione diversa da quella nominale di max. ± 0,5 mbar.

Einbaumaße / Dimensions / Cotes d'encombrement / Dimensioni [mm]

LGW...A4

ø 2,5 x 9 tief für Gerätstecker DIN EN 175 301-803
 2.5 x 9 dia. deep for DIN EN 175 301-803 equipment plug
 ø 2,5 x 9 de profond pour embase de connecteur DIN EN 175 301-803
 foro per spina ø 2,5 x 9 DIN EN 175 301-803

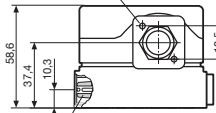

Druckanschluß G 1/4
 G 1/4 pressure connection
 Raccordement du fluide G 1/4

Druckanschluß G 1/8
 G 1/8 pressure connection
 Raccordement du fluide G 1/8
 attacco pressione G 1/8

Meßstutzen, integriert ø 9
 Measurement nozzle, integrated
 Prise de pression intégrée
 presa pressione, integrata

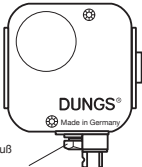

M 20 x 1,5 oder Steckanschluß
 für Leuchtungsdose nach
 DIN EN 175 301-803
 M20 x 1,5 or plug-type connection for cable socket according
 to DIN EN 175 301-803
 M20 x 1,5 ou fiche pour boîtier suivant DIN EN 175 301-803
 M20 x 1,5 oppure collegamento a spina per presa di rete a
 norme DIN EN 175 301-803

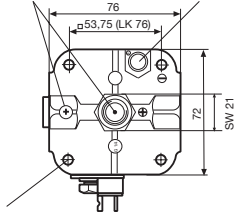

4 x ø 4,2
 für Schrauben M4 ISO 1201, ISO 4762
 for M4 ISO 1201, ISO 4762 screws
 pour vis M4 ISO 1201, ISO 4762
 per viti M4 ISO 1201, ISO 4762

LGW...A4/2

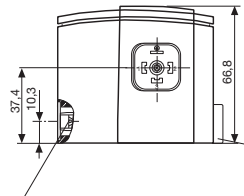

Verschlussschraube G 1/4 mit Dichtung
 Plug for G 1/4 pressure connection
 Bouchon pour raccord de pression G 1/4
 Tappo per attacco pressione G 1/4

Verschlussschraube mit Längsschlitz 1.0
 Screw cap with slot 1.0
 Bouchon fileté tête fendue 1.0
 Vite di chiusura con intaglio longitudinale 1.0

4 selbstfurchende Zylinderschrauben M3x14 Längsschlitz 0.8 und Kreuzschlitz DIN 7962-Z2
 4 vis auto-taradeuses tête cylindrique M3x14
 tête fendue 0.8 et empreinte cruciforme DIN 7962-Z2
 Quattro viti a testa cilindrica autofilettanti M3 x 14
 Intaglio longitudinale 0.8 e intaglio a croce DIN 7962-Z2



Druckanschluß G 1/8
 G 1/8 pressure connection
 Raccord de pression G 1/8
 Attacco pressione G 1/8

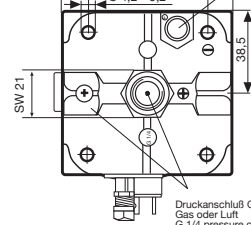

Druckanschluß G 1/4
 Gas oder Luft
 G 1/4 pressure connection
 gas or air
 Raccord de pression G 1/4
 Gaz ou air
 Attacco pressione G 1/4
 gas oppure aria

Einbaumaße / Dimensions / Cotes d'encombrement / Dimensioni [mm]
LGW... / ...A4

Innensechskantschraube M5 x 12, ähnlich ISO 4762
 M5 x 12 socket head screw, similar to ISO 4762
 Vis à six pans creux M5 x 12, similaire à ISO 4762
 Vite esagonale interna M5 x 12, simile ISO 4762

4 x ø 4,2 für Schrauben/for screws
 pour vis/per vite M4 ISO 1201,4762

Sechskantmutter M5 ISO 10511
 M5 ISO 10511 hex. nut
 Ecrou M5 ISO 10511
 Vite esagonale M5 ISO 10511

Druckanschluß G 1/4
 G 1/4 pressure connection
 Raccordement au fluide G 1/4
 Attacco pressione G 1/4

Verschlussschraube G 1/4
 G 1/4 screw plug
 Bouchon G 1/4
 Tappo di chiusura G 1/4

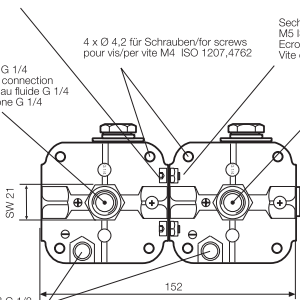

Druckanschluß G 1/8
 G 1/8 pressure connection
 Raccordement au fluide G 1/8
 Attacco pressione G 1/8

Meßstutzen, integriert ø 9
 Measurement nozzle,
 integrated ø 9
 Prise de pression intégrée ø 9
 Presa pressione integrata ø 9

O-Ring 14,3 x 2,4
 14,3 x 2,4 o ring
 Joint torique 14,3 x 2,4
 O-ring 14,3 x 2,4

Montageset Doppeldruckwächter
Double pressure switch: Side-By-Side Mounting Kit
Kit de montage pour pressostat double
Set di montaggio per il pressostat doppio
LGW...A4 / LGW...A4

(nicht für /2-Version)
(not for /2-Version)
(pas pour la version /2)
(no per versione /2)

Bestell-Nr.
 Order-No.
 Réf. de commande
 Nr. codice
213 910

O-Ring Ø 14,3 x 2,4
 O ring Ø 14,3 x 2,4
 Joint torique Ø 14,3 x 2,4
 O-Ring Ø 14,3 x 2,4

Sechskantmutter M5 ISO 10511
 M5 hex. nut ISO 10511
 Ecrou M5 ISO 10511
 Vite esagonale M5 ISO 10511

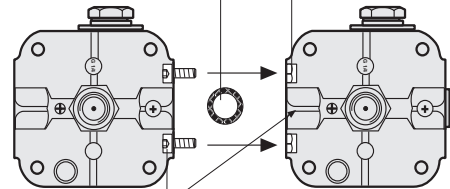

Innensechskantschraube M5 x 12, ähnlich ISO 4762
 M5 x 12 hex. socket bolt (ISO 4762)
 Vis six-pans creux M5 x 12, similaire à ISO 4762
 Vite esagonale interna M5 x 12, simile ISO 4762

Vor Zusammenbau: Schraube aus Meßstutzen entfernen.
 Before assembly: Remove the screw from the test nipple.
 Avant assemblage: retirer la vis de la prise de mesure
 Prima dell'assemblaggio, togliere la vite dal raccordo per misurazione.

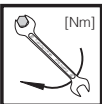

max. Drehmomente / Systemzubehör
max. torque / System accessories
max. couple / Accessoires du système
max. coppia / Accessorio di sistema

ø 3	M 3	M 4	G 1/8	G 1/4
1,2 Nm	1,2 Nm	2,5 Nm	5 Nm	7 Nm



Geeignetes Werkzeug einsetzen!
Please use proper tools!
Utiliser des outils adaptés!
Impiegare gli attrezzi adeguati!



Gerät darf nicht als Hebel benutzt werden
Do not use unit as lever.
Ne pas utiliser le pressostat comme un levier.
L'apparecchio non deve essere usato come leva.

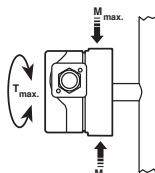

DN	6	8	
Rp	1/8	1/4	
M _{max.}	25	35	[Nm] t ≤ 10 s
T _{max.}	15	20	[Nm] t ≤ 10 s

Einbau
LGW...A4, LGW...A4/2

1. Der Druckwächter wird direkt auf einen Rohrstutzen mit R 1/4 Außengewinde aufgeschraubt. Bild 1.
2. Nach Einbau Dichtheits- und Funktionskontrolle durchführen.

⚠ **Auf vibrationsfreien Einbau achten! Bild 2.**

Installation of
LGW...A4, LGW...A4/2

1. Screw the pressure switch directly on a tube socket with R 1/4 outer thread (see Fig. 1).
2. After installation, perform a leakage and function test.

⚠ **Ensure that the pressure switch is installed free of vibration! (see Fig. 2).**

Montage
LGW...A4, LGW...A4/2

1. Le pressostat peut se visser directement sur un piquage R 1/4" Fig.1.
2. Après le montage contrôler la fonction et l'étanchéité.

⚠ **Veiller à ce que l'appareil ne subisse pas de vibrations! Fig. 2.**

Montaggio
LGW...A4, LGW...A4/2

1. Il pressostato viene avvitato direttamente su un tubo di sostegno con filetto esterno R 1/4 (Fig.1)
2. Dopo il montaggio effettuare i controlli di tenuta e funzionalità.

⚠ **Evitare possibilità di vibrazioni! Fig 2.**

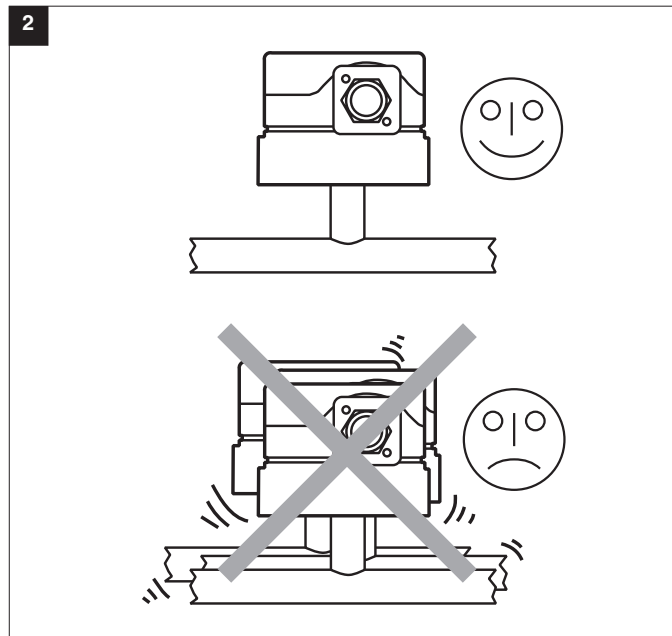
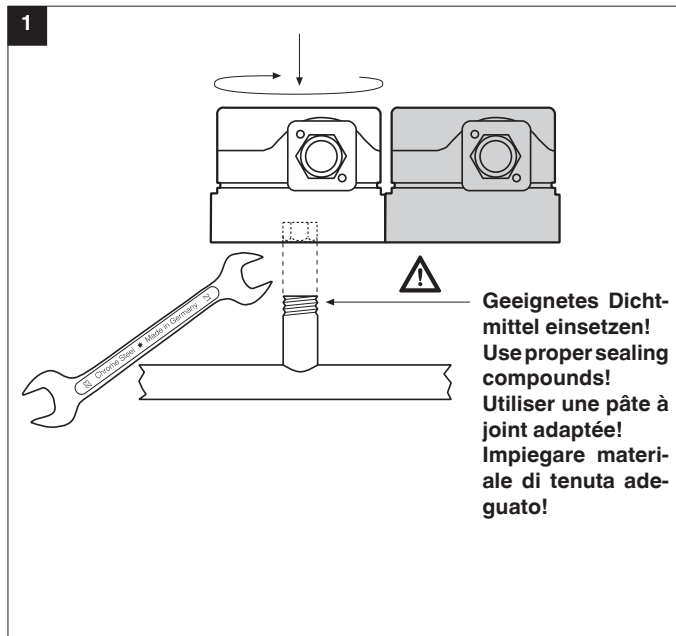

Elektrischer Anschluß
Electrical connection
Raccordement électrique
Allacciamento elettrico
IEC 730-1 (VDE 0631 T1)

M20 x 1,5

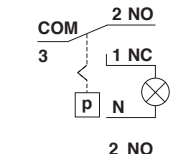
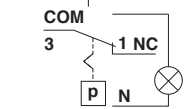
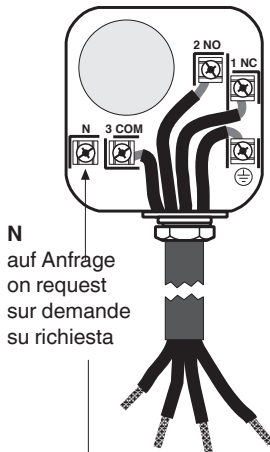

DIN EN 175 301-803

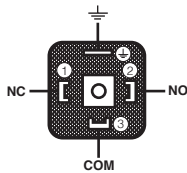

⚠ Erdung nach örtlichen Vorschriften.

Grounding acc. local regulations.

Mise à la terre selon normes locales.

Messa a terra secondo prescrizioni locali.

Zur Erhöhung der Schaltleistung wird bei DC-Anwendungen < 20 mA und 24 V der Einsatz eines RC-Gliedes empfohlen.

To increase the switching capacity, we recommend that you use a RC device for current values < 20 mA and 24 V d.c. applications.

Pour augmenter la puissance de rupture, l'utilisation d'un circuit RC est préconisée pour les applications à courant continu < 20 mA et 24 V.

Per aumentare la potenza d'insierimento con applicazioni DC < 20 mA e 24 V, consigliamo l'impiego di un elemento RC.

Schaltfunktion
Switching function
Schéma de fonctionnement
Funzione di commutazione
pressostato
LGW...A4, LGW...A4/2

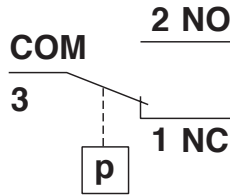

Bei steigendem Druck:
 1 NC öffnet, 2 NO schließt.
Bei fallendem Druck:
 1 NC schließt, 2 NO öffnet.

While pressure is increasing:
 1 NC opens, 2 NO closes.
While pressure is decreasing:
 1 NC closes, 2 NO opens.

Pression montante:
 1 NC ouvre, 2 NO ferme.
Pression descendante:
 1 NC ferme, 2 NO ouvre

Con pressione in salita:
 1 NC apre, 2 NO chiude.
Con pressione in discesa:
 1 NC chiude, 2 NO apre

Druckanschluß
Pressure port
Prise de pression
Attacco pressione

- 1 Druckanschluß G 1/4 (+) für Gas und Luft
- 1 Pressure port G 1/4 (+) for gas and air
- 1 Prise de pression G 1/4 (+) pour gaz et air
- 1 Attacco pressione G 1/4 (+) per gas ed aria

- 2 Druckanschluß G 1/8 (-) für Luft
- 2 Pressure port G 1/8 (-) **only** for air
- 2 Prise de pression G 1/8 (-) **uniquement** pour l'air
- 2 Attacco pressione G 1/8 (-) **solo** per l'aria

	Familie 1 + 2 + 3
	Family 1 + 2 + 3
	Famille 1 + 2 + 3
	Famiglia 1 + 2 + 3

	Luft, Rauch- und Abgase
	Air, flue and exhaust gases
	Air, fumée et gaz brûlés
	Aria, gas di combustione e di scarico

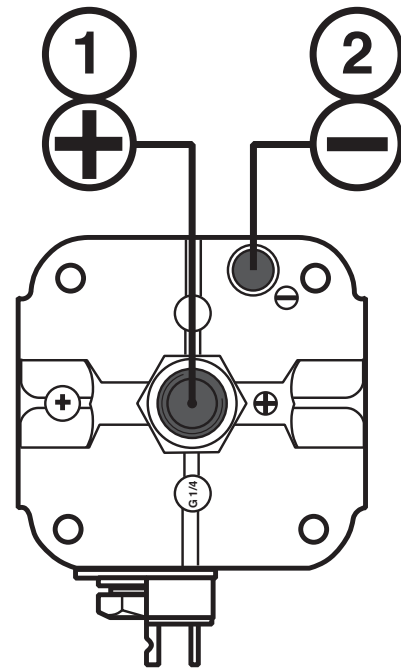

Einstellung des Druckwächters

Haube mit geeignetem Werkzeug demontieren, Schraubendreher No. 3 bzw. PZ 2, Bild 1. Haube abnehmen.

⚠ Berührungsschutz ist nicht grundsätzlich gewährt, Kontakt mit spannungsführenden Teilen möglich.

Einstellung LGW ... A4

Druckwächter am Einstellrad mit Skala auf vorgeschriebenen Drucksollwert einstellen, Bild 2.

Anleitung des Brennerherstellers beachten!

Druckwächter schaltet bei steigendem Druck: Einstellung ↑. Druckwächter schaltet bei fallendem Druck: Einstellung ↓. Haube wieder aufsetzen!

Setting the pressure switch

Dismount the hood using a suitable tool, e.g. screwdriver no. 3 or PZ2, Fig. 1. Remove hood.

⚠ There is no protection against accidental contact. Contact with live parts is possible.

Setting LGW ... A4

Set the pressure switch at the setting wheel to the specified pressure setpoint using the scale, Fig. 2.

Follow the instructions of the burner manufacturer!

Pressure switch switches as pressure increases: Setting ↑. Pressure switch switches as pressure reduces: Setting ↓. Remount hood!

Réglage des pressostats

Enlever les vis du capot en utilisant un tournevis N°3. ou PZ 2, Fig 1. Enlever le capot.

⚠ La protection n'est pas garantie, contact avec des pièces sous tension possible.

Réglage de LGW ... A4

Régler le pressostat avec son bouton gradué à la valeur désirée Fig. 2.

Respecter les recommandations du constructeur du brûleur!

Le pressostat commute par pression montante: réglage ↑. Le pressostat commute par pression descendante: réglage ↓. Remonter le capot!

Regolazione del pressostato

Smontare la calotta con un attrezzo adeguato, ossia cacciavite nr. 3 - rispettiv, PZ 2, figura 1. Togliere la calotta.

⚠ Non é sostanzialmente garantita la protezione da scariche, é possibile il contatto con conduttori di tensione.

Regolazione LGW ... A4

Tarare il pressostato, come in figura 2, sul valore di pressione nominale prescritto, agendo sulla rotella della scala graduata .

Prestare attenzione alle prescrizioni del produttore del bruciatore!

Il pressostato scatta con pressione in salita: regolazione ↑. Il pressostato scatta con pressione in discesa: regolazione ↓. Rimontare la calotta!

1



2

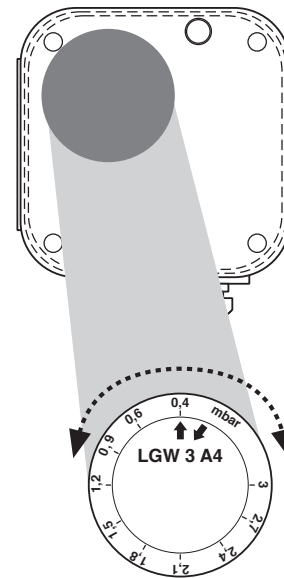

Ersatzteile / Zubehör Spare parts / Accessories Pièces de rechange / access. Parti di ricambio / Accessori	Bestell-Nummer Ordering No. No. de commande Codice articolo
Verschlussschraube G 1/4 mit Dichtring (1 x) Screw plug G 1/4 with sealing ring(1 x) Bouchon G 1/4 avec joint (1 x) Tappo a vite G 1/4 con anello di tenuta (1 x)	266 044
Verschlussschraube G 1/8 mit Dichtring (1 x) Screw plug G 1/8 with sealing ring(1 x) Bouchon G 1/8 avec joint (1 x) Tappo a vite G 1/8 con anello di tenuta (1 x)	270 802
Befestigungswinkel, Metall Metal mounting bracket Equerre de fixation, métal Cantonale di fissaggio in metallo	230 288
Winkel-Einschraubstutzen G 1/4 nur für Luft G 1/4 screw-in glands only for air Manchon coudé G 1/4 pour air uniquement Tronchetto avvitabile angolare G 1/4 solo per aria	230 279
Winkel-Einschraubstutzen G 1/8 nur für Luft G 1/8 screw-in glands only for air Manchon coudé G 1/8 pour air uniquement Tronchetto avvitabile angolare G 1/8 solo per aria	230 278
Montage-Set Doppeldruckwächter (nicht für /2-Version) Double pressure switch: Side- By-Side Mounting Kit (not for /2-version) Kit de montage pour pressostat double (pas pour la version /2) Set di montaggio per il pressostato doppio (non per versione /2)	213 910
Meßstutzen G 1/4 mit Dichtring (1 x) G 1/4 test nipple and seal ring (1 x) Prise de mesure G 1/4 avec bague d'étanchéité (1 x) Attacco pressione G 1/4 con anello di tenuta (1 x)	266 042
Meßstutzen G 1/8 mit Dichtring (1 x) G 1/8 test nipple and seal ring (1 x) Prise de mesure G 1/8 avec bague d'étanchéité (1 x) Attacco pressione G 1/8 con anello di tenuta (1 x)	230 397
Zylinderschraube Cheese head screw Vis à tête cylindrique Vite a testa cilindrica ø 3 x 14 (2 x)	266 045

Ersatzteile / Zubehör Spare parts / Accessories Pièces de rechange / access. Parti di ricambio / Accessori	Bestell-Nummer Ordering No. No. de commande Codice articolo						
Montage-Set Glimmlampen Neon glow lamp assembly set Lampes fluorescentes, kit de montage Set die montaggio lampadina a bagliore grün/green/verte/verde	<table border="1"> <tr> <td>230 V</td> <td>24 V</td> </tr> <tr> <td>248 239</td> <td>248 240</td> </tr> </table>	230 V	24 V	248 239	248 240		
230 V	24 V						
248 239	248 240						
Montage-Set Glimmlampen Neon glow lamp assembly set Lampes fluorescentes, kit de montage Set die montaggio lampadina a bagliore gelb/yellow/jaune/giallo	<table border="1"> <tr> <td>230 V</td> <td>120 V</td> <td>24 V</td> </tr> <tr> <td>231 773</td> <td>231 772</td> <td>231 774</td> </tr> </table>	230 V	120 V	24 V	231 773	231 772	231 774
230 V	120 V	24 V					
231 773	231 772	231 774					
Set: Gerätestecker G3, 3-pol + E Kit: G3 equipment plug, 3-pin + E Kit: Fiche G3, 3 pôles + terre Set composto da: Spina G3 a 3 poli + terra nur/only/pour/solo LGW...A4	219 659						
Leitungsdose 3 pol. + E grau, GDMW Power socket, 3-pole + E grey, GDMW Connecteur gris 3 pôles + terre Presa di corrente a 3 poli + terra, grigia, GDMW	210 318						



Arbeiten am Druckwächter dürfen nur von Fachpersonal durchgeführt werden.

Work on the pressure switch may only be performed by specialist staff.

Seul du personnel spécialisé peut effectuer des travaux sur le pressostat.

Qualsiasi operazione effettuata sul pressostato deve essere fatta da parte di personale competente.



Kondensat darf nicht in das Gerät gelangen. Bei Minustemperaturen, durch Vereisung Fehlfunktion/Ausfall möglich.

Do not allow condensate to flow into the equipment. In case of sub-zero temperatures, malfunction or equipment failure may be possible due to icing.

Eviter l'entrée de condensat dans le pressostat, une prise en glace par température négative nuirait à son fonctionnement.

Nell'apparecchio non deve infiltrarsi alcuna condensa. Alle temperature negative sarebbero possibili disfunzioni dovute a formazione di ghiaccio.

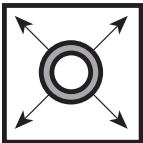

Rohrleitungsdichtheitsprüfung: Kugelhahn vor dem Druckwächter schließen.

Pipeline leakage test: close ball valve upstream of the pressure switch.

Contrôle de l'étanchéité de la conduite: fermer le robinet à boisseau sphérique avant le pressostat.

Per la prova di tenuta delle tubature: chiudere il rubinetto a sfera davanti al pressostato.



Nach Abschluß von Arbeiten am Druckwächter: Dichtheitskontrolle und Funktionskontrolle durchführen.

On completion of work on the pressure switch, perform a leakage and function test.

Une fois les travaux sur le pressostat terminés, procéder toujours à un contrôle d'étanchéité et de fonctionnement.

Al termine dei lavori effettuati su un pressostato: predisporre un controllo sia della tenuta che del funzionamento.



Niemals Arbeiten durchführen, wenn Gasdruck oder Spannung anliegt. Offenes Feuer vermeiden. Örtliche Vorschriften beachten.

Never perform work if gas pressure or power is applied. No naked flame. Observe local regulations.

Ne jamais effectuer des travaux sous pression ou sous tension. Eviter toute flamme ouverte. Observer les réglementations.

In nessun caso si debbono effettuare lavori in presenza di pressione gas o di tensione elettrica. Evitare i fuochi aperti e osservare le prescrizioni di sicurezza locali.



Bei Nichtbeachtung der Hinweise sind Personen- oder Sachfolgeschäden denkbar.

If these instructions are not heeded, the result may be personal injury or damage to property.

En cas de non-respect de ces instructions, des dommages corporels ou matériels sont possible.

La non osservanza di quanto suddetto può implicare danni a persone o cose.



Silikonöle und flüchtige Silikonbestandteile (Siloxane) in der Umgebung vermeiden. Fehlfunktion / Ausfall möglich.

Avoid silicone oils and volatile silicones (siloxanes) in the environment. Malfunction/failure possible.

Eviter les huiles de silicone et les éléments de silicone volatils (siloxanes) dans l'environnement. Dysfonctionnement / panne possibles.

Evitare oli silconici e componenti silconici volatili (silossani) nell'ambiente. Possibile disfunzione / guasto.



Alle Einstellungen und Einstellwerte nur in Übereinstimmung mit der Betriebsanleitung des Kessel-/Brennerherstellers ausführen.

Any adjustment and application-specific adjustment values must be made in accordance with the appliance-/boiler manufacturers instructions.

Effectuer tous les réglages et réaliser les valeurs de réglage uniquement selon le mode d'emploi du fabricant de chaudières et de brûleurs.

Realizzare tutte le impostazioni e i valori impostati solo in conformità alle istruzioni per l'uso del costruttore della caldaia/ del bruciatore.



Die Druckgeräterichtlinie (PED) und die Richtlinie über die Gesamtenergieeffizienz von Gebäuden (EPBD) fordern eine regelmäßige Überprüfung der Wärmeerzeuger zur langfristigen Sicherstellung von hohen Nutzungsgraden und somit geringster Umweltbelastung.

Es besteht die Notwendigkeit sicherheitsrelevante Komponenten nach Erreichen ihrer Nutzungsdauer auszutauschen:

The Pressure Equipment Directive (PED) and the Energy Performance of Buildings Directive (EPBD) require a periodic inspection of heat generators in order to ensure a high degree of efficiency over a long term and, consequently, the least environmental pollution.

It is necessary to replace safety-relevant components after they have reached the end of their useful life:

La directive équipements sous pression (PED) et la directive sur la performance énergétique des bâtiments (EPBD) exigent une vérification régulière des générateurs de chaleur afin de garantir à long terme des taux d'utilisation élevés et par conséquent une charge environnementale minimum.

Il est nécessaire de remplacer les composants relatifs à la sécurité lorsqu'ils ont atteint la fin de leur vie utile :

La direttiva per apparecchi a pressione (PED) e la direttiva per l'efficienza dell'energia totale per edifici (EPBD), esigono il controllo regolare dei generatori di calore per la garanzia a lungo termine di un alto grado di rendimento e quindi di basso inquinamento ambientale.

Ciò rende necessaria la sostituzione di componenti rilevanti dal punto di vista della sicurezza alla scadenza della loro durata di utilizzazione:

Sicherheitsrelevante Komponente Safety-relevant component Composant relatif à la sécurité Componenti rilevanti per la sicurezza	Konstruktionsbedingte Lebensdauer Design-related service life Durée de vie prévue Durata di vita di progetto		Norm Standard Norme Norma	Dauerhafte Lagertemperatur Permanent storage temperature Température de stockage permanente Temperatura di stoccaggio permanente
	Zyklenzahl Operating cycles Cycle d'opération Numero di cicli di funzionamento	Jahre Years Années Anni		
Ventilprüfsysteme / Valve testing systems / Systèmes de contrôle de vanne / Sistemi di controllo valvole	250 000	10	EN 1643	0...45 °C 32...113 °F
Gas / Gas / Gaz / Gas Druckwächter / Pressure switch / Manostat / Pressostato	50 000	10	EN 1854	
Luft / Air / Air / Aria Druckwächter / Pressure switch / Manostat / Pressostato	250 000	10	EN 1854	
Gas mangelschalter / Low gas pressure switch / Pressostat gaz basse pression / Pressostato gas di minima pressione	N/A	10	EN 1854	
Feuerungsmanager / Automatic burner control / Dispositif de gestion de chauffage / Gestione bruciatore	250 000	10	EN 298 EN 230	
UV-Flammenfühler ¹ UV flame sensor ¹ Capteur de flammes UV ¹ Sensore fiamma UV ¹	N/A	10 000 h ³	---	
Gasdruckregelgeräte ¹ Gas pressure regulators ¹ Dispositifs de réglage de pression du gaz ¹ Regolatori della pressione del gas ¹	N/A	15	EN 88-1 EN 88-2	
Gasventil mit Ventilprüfsystem ² Gas valve with valve testing system ² Vanne de gaz avec système de contrôle de vanne ² Valvola del gas con sistema di controllo valvola ²	nach erkanntem Fehler after error detection après détection d'erreur dopo segnalazione di errore		EN 1643	
Gasventil ohne Ventilprüfsystem ² Gas valve without valve testing system ² Vanne de gaz sans système de contrôle de vanne ² Valvola del gas senza sistema di controllo valvola ²	DN ≤ 25 200 000 25 < DN ≤ 80 100 000 80 < DN ≤ 150 50 000	10	EN 161	
Gas-Luft-Verbindsysteme / Gas-air ratio control system / Systèmes combinés gaz/air / Sistemi di miscelazione gas-aria	N/A	10	EN 88-1 EN 12067-2	

¹ Nachlassende Betriebseigenschaften wegen Alterung / Performance decrease due to ageing /
Réduction de performance due au vieillissement / Riduzione delle prestazioni dovuta all'invecchiamento

² Gasfamilien II, III / Gas families II, III / Familles de gaz II, III / per i gas delle famiglie II, III

³ Betriebsstunden / Operating hours / Heures de service / Ore di esercizio

N/A nicht anwendbar / not applicable / non applicable / non applicabile

Lagerzeiten / Storage times / Périodes de stockage / Tempi di stoccaggio

Lagerzeiten ≤ 1 Jahr verkürzen nicht die konstruktionsbedingte Lebensdauer.

Storage time ≤ 1 year does not reduce the design-related service life.

Les périodes de stockage ≤ 1 an ne réduisent pas la durée de vie liée à la conception.

I tempi di stoccaggio ≤ 1 anno non riducono la durata di vita di progetto.

DUNGS empfiehlt eine maximale Lagerzeit von 3 Jahren.

DUNGS recommends a maximum storage time of 3 years.

DUNGS recommande une durée de stockage maximale de 3 ans.

DUNGS raccomanda un tempo massimo di stoccaggio di 3 anni.

Änderungen, die dem technischen Fortschritt dienen, vorbehalten. / We reserve the right to make modifications in the course of technical development. /
Sous réserve de toute modification constituant un progrès technique. / Ci riserviamo qualsiasi modifica tecnica e costruttiva.

Hausadresse
Head Offices and Factory
Usine et Services Administratifs
Amministrazione e Stabilimento

Karl Dungs GmbH & Co. KG
Karl-Dungs-Platz 1
D-73660 Urbach, Germany
Telefon +49 7181-804-0
Telefax +49 7181-804-166

Briefadresse
Postal address
Adresse postale
Indirizzare la corrispondenza a

Karl Dungs GmbH & Co. KG
Postfach 12 29
D-73602 Schorndorf
e-mail info@dungs.com
Internet www.dungs.com

Hausadresse
Head Offices and Factory
Usine et Services Administratifs
Amministrazione e Stabilimento

Karl Dungs GmbH & Co. KG
Karl-Dungs-Platz 1
D-73660 Urbach, Germany
Telefon +49 7181-804-0
Telefax +49 7181-804-166

Briefadresse
Postal address
Adresse postale
Indirizzare la corrispondenza a

Karl Dungs GmbH & Co. KG
Postfach 12 29
D-73602 Schorndorf
e-mail info@dungs.com
Internet www.dungs.com